



Installation and Operation Installations
High Voltage Battery
GE-FL60



Version: V1.1

Table of contents

All Rights Reserved	3
About This Manual	3
1 Safety Precautions	4
1.1 Personal Requirements	4
1.2 Electrical Safety	5
1.3 Battery Safety	6
1.4 Hoisting and Transportation	6
1.5 Installation and Wiring	6
1.6 Operation and Maintenance	7
1.7 Disposal of Waste	7
2 Product Description	7
2.1 Product Introduction	7
2.2 External Design	9
2.3 Air-conditioner Design	10
2.4 Internal Design	11
2.4.1 Internal Equipment	11
2.4.2 Battery Introduction	13
2.4.3 Indicator light Design	16
3 Transport and storage	19
3.1 Transportation	19
3.2 Transportation Requirement	19
3.3 Storage requirement	20
4 Mechanical Installation	21
4.1 Inspection Before Installation	21
4.1.1 Open the package	21
4.1.1 Deliverables Inspection	24
4.1.2 Product Inspection	24
4.2 Installation Environment	25
4.3 Installation Spacing Requirement	26
4.4 Installation of inverters and BESS	28
4.5 Transportation and lifting	29
4.5.1 Transportation	29
4.5.2 Hoisting Equipment	31
4.5.3 Hoisting	32
4.6 Fixing Methods	33
5. Electrical connection	34
5.1 Electrical connection Overview	34
5.2 Preparation before connection	35

5.4 Cable connection	36
5.4.1 Cable connections inside BESS	36
5.4.2 Auxiliary power supply	39
5.4.3 Cable connection between BESS	34
5.4.4 Cable connection between the inverter and BESS	35
5.5 Operation after cable connection	35
5.6 Battery Connection	36
6 Activate BESS	36
Power on and off	36
6.1 Power-on procedure	36
6.2 Power-off procedure	37
6.3 Unplanned (emergency) shut down	38
7 Fire Suppression system	38
7.1 Fire Suppression equipment	38
7.1.1 Aerosol fire suppression system	39
7.1.2 Fire suppression water pipe system	39
7.2 Exhaust system	41
8 Troubleshooting	41
9. Inspection and maintenance	42
9.1 Basic Information	42
9.2 Maintenance item and period	43
9.3 Battery Maintenance	44
9.4 Disassembly and installation	46
9.4.1 Disassemble and install the battery pack	46
9.4.2 Disassemble and install the PDU	48
10 Upgrade	50
10.1 USB Upgrade	50
10.2 PC Upgrade	50
10.3 PCS Upgrade	53
11. Battery recycling	55
11.1 Recovery process and steps of cathode materials	55
11.2 Recovery of anode materials	55
11.3 List of recycling equipment	56
12 Contact Information	56
12.1 System Parameter	56
12.2 Contact Information	57

All Rights Reserved

No part of this document can be reproduced in any form or by any means without the prior written permission of NINGBO DEYE ESS TECHNOLOGY CO., LTD (-hereinafter "Deye ESS").

Trademarks

Deye and other Deye trademarks used in this manual are owned by Deye ESS. All other trademarks or registered trademarks mentioned in this manual are owned by their respective owners.

Software Licenses

- It is prohibited to use data contained in firmware or software developed by Deye ESS, in part or in full, for commercial purposes by any means.
- It is prohibited to perform reverse engineering, cracking, or any other operations that compromise the original program design of the software developed by Deye ESS.

About This Manual

This manual describes the transportation and storage, mechanical installation, electrical connection, power-on and power-off operation, troubleshooting, and maintenance of the BESS.

How to Use This Manual

Please read this manual carefully before using the product and keep it properly at a place for easy access.





In order to provide the best customer experience, contents of the manual may be updated and amended continuously, so it is possible that there may be some errors or slight inconsistency with the actual product. Please refer to the actual product purchased, and the latest manual can be obtained from service-ess@deye.com.cn (www.deyeess.com) or sales channels.

The figures in this manual are for reference only. The actual product received may differ.

Symbol Explanations

To ensure the safety of the users and their properties when they use the product and to make sure that the product is used in an optimal and efficient manner, this manual provides users with the relevant safety information highlighted by the following symbols.

Below is a list of symbols used in this manual. Please read it carefully to make better use of this manual.

	Danger! Failure to follow the instructions bearing this sign may result in a serious accident resulting in death or serious injury.
	Warning! Failure to follow the instructions of this sign may result in a serious accident resulting in serious personal injury.
	Caution! Failure to follow the instructions of this sign may result in minor or moderate injury.
	Notice! Provide information that is considered important but not relevant to the danger. The information relates to property damage.

This product is designed to an integrated system, which must be performed by a qualified person trained in electrical engineering and familiar with the characteristics and safety requirements of lithium batteries. Do not use this product if you are unsure if you possess the necessary skills to complete this integration.

Abbreviation:

Complete designation	Abbreviations
Battery Module	Module
Battery Pack	Pack
Power Distribution Unit	PDU
Accessory box	/
Energy Storage System	BESS
Battery Base	Base
Manual service disconnect	MSD

1 Safety Precautions

1.1 Personal Requirements

The hoisting, transportation, installation, wiring, operation, and maintenance of the BESS must be carried out by professional electrical technicians in accordance with local regulations. The professional technician is required to meet the following requirements:

- Should know electronic, electrical wiring and mechanical expertise, and be familiar with electrical and mechanical schematics.
- Should be familiar with the composition and working principles of the BESS and its corollary equipment.
- Be able to quickly respond to hazards and emergencies that occur during installation and commissioning.
- Be familiar with the relevant standards and specifications of the country/region where the project is located.

1.2 Electrical Safety



Danger!

- Touching the power grid or the contact points and terminals in the devices connected to the power grid may lead to electric shock! All circuit connectors must be disconnected during maintenance.
 - The battery side or the power grid side may generate voltage. Always use a standard voltmeter to ensure that there is no voltage before touching.
-



Danger!

- Lethal voltages are present inside the product!
 - Note and observe the warnings on the product.
 - Respect all safety precautions listed in this manual and other pertinent document.
 - Respect the protection requirements and precautions of the lithium battery
-



Danger!

When the power supply is disconnected, there may still be electricity in the battery. Wait for 10 minutes and ensure that the device has no voltage before performing any operation.



Warning!

- All hoisting, transportation, installation, wiring, operation, and maintenance must be carried out complying with the relevant codes and regulations of the country where the project is located.
 - Always use the product in accordance with the requirements described in this manual. Otherwise, equipment damage may occur.
-



Warning!

- All hoisting, transportation, installation, wiring, operation, and maintenance must be carried out complying with the relevant codes and regulations of the country where the project is located.
 - Always use the product in accordance with the requirements described in this manual. Otherwise, equipment damage may occur.
-



Notice!

To prevent accidents caused by misuse or unrelated persons, place necessary warning signs or barriers near the product.

1.3 Battery Safety

It is very important to read the owner's manual carefully before installing or using the battery. Follow any instructions or warnings in this document, otherwise it may result in electric shock, serious injury, or death, or may damage the battery and render it inoperable.

After the battery is fully discharged, it needs to be charged within 48 hours. The battery is not charged as required, resulting in loss of battery capacity or irreversible damage. If the battery is stored for a long time, it is required to be charged every six months, and the SOC should not be less than 50%.

- Do not use cleaning solvents to clean batteries. Do not expose the battery to flammable or irritating chemicals or vapors.
- Do not connect the battery directly to the photovoltaic solar power wire.
- Do not paint any part of the battery, including any internal or external components.
- Please do not use batteries provided by the company with other batteries, including but not limited to batteries of other brands or batteries with different rated capacities.
- Do not insert any foreign matter into any part of the battery.
- Handle or handle with care to avoid battery damage, drop, or leakage.
- Do not store batteries with inflammable and explosive materials. This may cause product damage or property loss.

Maintain the battery according to this manual. Deye ESS is not responsible for insurance and claims if maintenance is not performed in accordance with this manual.



1.4 Hoisting and Transportation

Follow the procedure of work of heights when walking on the top of the container.

1.5 Installation and Wiring

In the whole process of mechanical installation, the relevant standards and requirements of the project location must be strictly observed.

Please refer to the wiring method recommended by Deye ESS.

1.6 Operation and Maintenance

Personal protective equipment must be equipped when maintaining and maintaining the BESS. Maintenance personnel must wear protective equipment such as goggles, helmets, insulating shoes, and gloves.

Users are not allowed to perform battery maintenance without guidance. Warning Except the maintenance operations described in this manual, do not perform other maintenance operations to avoid electric shock. If necessary, please contact Deye ESS Customer Service center for maintenance.

Removing or repairing the battery may cause the battery to catch fire. The replacement of internal parts must be carried out by professionals. Do not spray paint internal or external parts of the product. Do not use cleaning agents to clean products or expose them to harsh chemicals.

1.7 Disposal of Waste

When the equipment is at the end of its service life, it cannot be disposed of together with domestic waste. Some parts can be recycled, and some parts will cause environmental pollution.

2 Product Description

2.1 Product Introduction

GE-FL60 lithium iron phosphate battery the new energy storage products developed and produced by DEYE ESS, which can be used to support the reliable power supply of various equipment and systems. The GE-FL60 is particularly suitable for high-rate cyclic charging and discharging scenarios.

GE-FL60 has built-in local management system, it can manage and monitor, voltage, current, temperature, humidity, smoke, etc. In addition, BMS also balances the capacity of the battery and extends the cycle life of the system. Meanwhile, support black start function, Off grid operation, and built-in aerosol fire suppression device and combustible gas detection exhaust system. Multiple battery systems can be expanded in parallel for greater capacity and longer power support duration requirements.

2.2 External Design

Cabinet Appearance

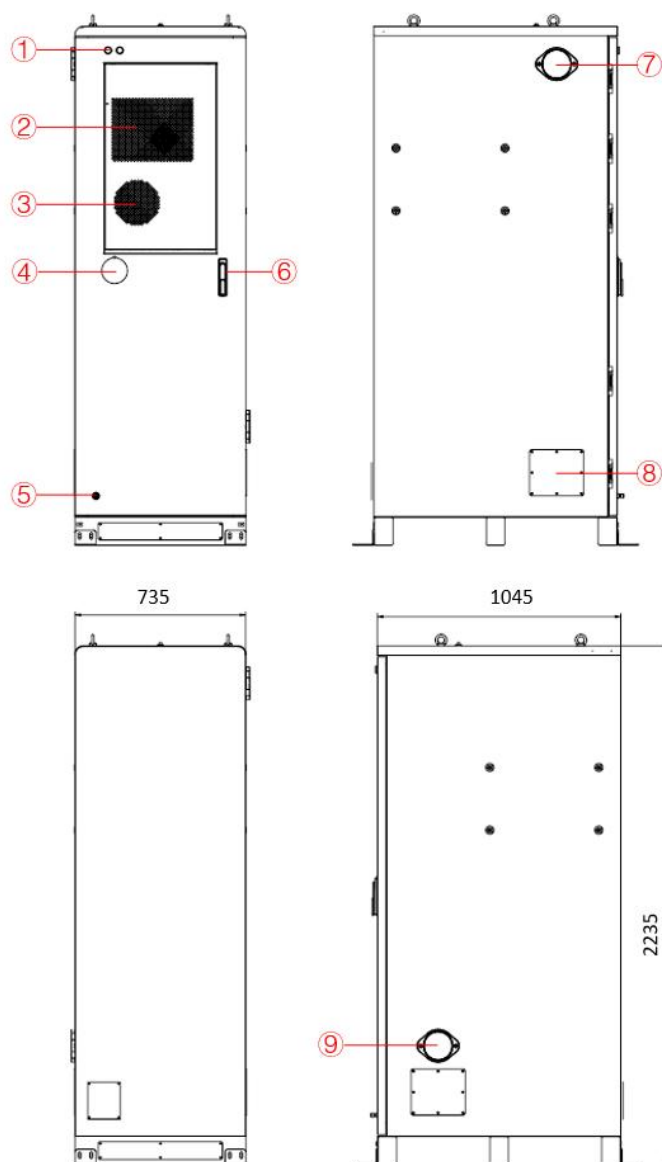

<p>① Indicator light: When the green light comes on, the BESS is Run. When the red light comes on, the BESS gives an alarm.</p>	<p>⑥ Door switch: Insert the key to open the ESS.</p>
<p>② Air conditioning outlet: Hot air in the air conditioner comes out from this outlet.</p>	<p>⑦ Air outlet: When combustible gas is detected the BESS, it can be discharged through this outlet. And the outlet will automatically pop out and need to be manually reset after use.</p>
<p>③ Air conditioning inlet: Outdoor air enters air conditioner through this opening.</p>	<p>⑧ Cable outlet: The cable outlet during parallel operation or connected to the inverter.</p>
<p>④ Emergency stop switch: When the BESS out of order, activate this switch to stop the BESS.</p>	<p>⑨ Air inlet: When combustible gas is detected, the inlet will automatically pop out and need to be manually reset after use.</p>
<p>⑤ Water outlet: Air conditioning condensed water.</p>	

2.3 Air-conditioner Design

System built-in air conditioner cooling

The air conditioning system uses air cooled air conditioner, keep the BESS at a constant temperature.

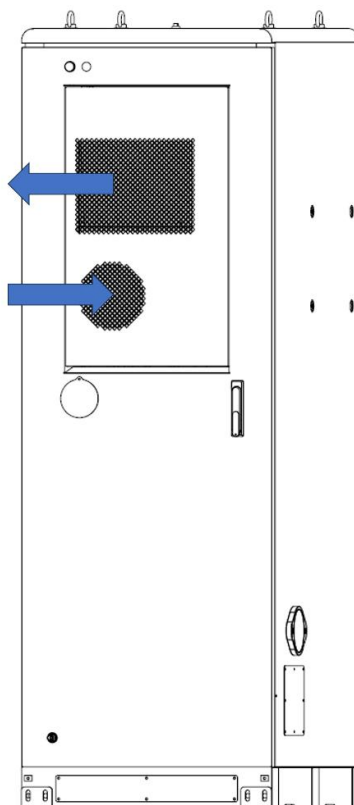

Energy storage Air Conditioning	
Model	DY-CNA20-BP(US)
Rated Voltage	AC 240V
Rated Frequency	60Hz
Rated Cooling Capacity	2100W
Rated Cooling Current	4.15A
Rated Cooling Power Input	900W
Rated Heating Capacity	1650W
Rated Heating Power Input	1700W
Rated Heating Current	7.9A
Minimum Circuit Ampacity	5.3A
Maximum Overcurrent Protection	10A
Rated Current of Power conversion equipment	8.5A
Max Operating Pressure	2.7Mpa
Max.Suction Pressure	1.6Mpa
Max.Discharge Pressure	2.7Mpa
Air Flow Volume	630m ³ /h
Electric Shock Prevention	I
Water-proof Class	IP55
Refrigerant	R134a/330g
Dimension (W×H×D)	478×798×304mm
Net Weight	48.5kg

2.4 Internal Design

2.4.1 Internal Equipment

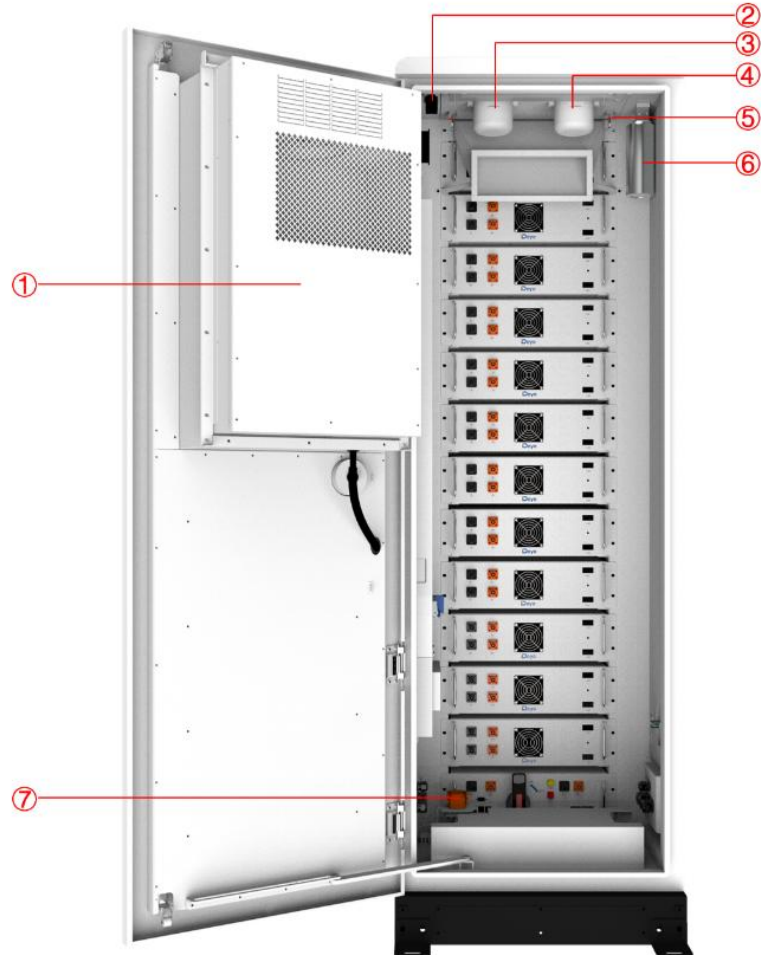

① Air conditioner	Cooling the BESS.
② Travel switch	Check whether the BESS system door is closed.
③ Smoke detector	A device used to detect smoke in a fire and sound an alarm when smoke is detected.
④ Heat detector	A device used to measure temperature and sound an alarm if it detects excessive temperature.
⑤ Fire suppression water pipe	Fire suppression and cooling.
⑥ Aerosol fire extinguishing device	When the BESS is detected to be on fire, aerosol is emitted to extinguish the fire.
⑦ Manual service disconnect	In order to protect the safety of technicians servicing in high voltage environments or respond to sudden events, the connection of the high voltage circuit can be quickly separated.

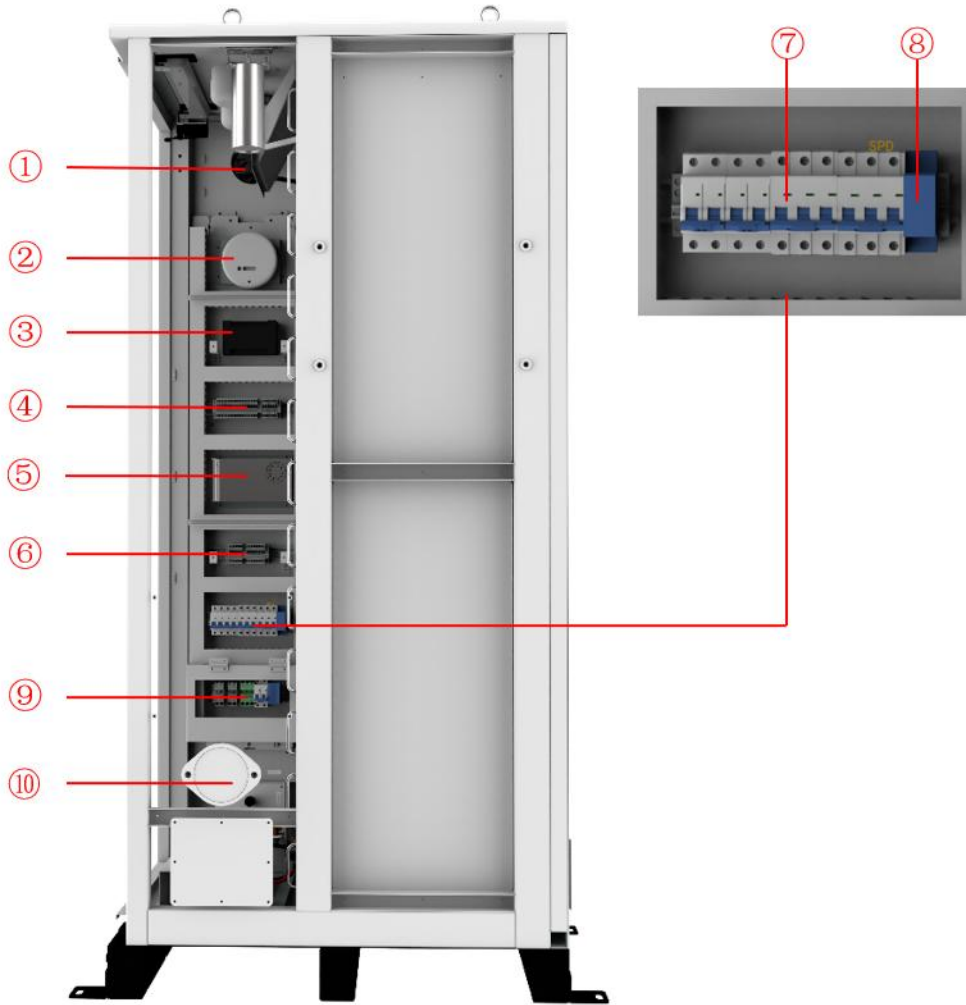

① Air outlet	When combustible gas is detected, the outlet will automatically pop out and need to be manually reset after use.
② Combustible gas sensor	Detect combustible gases and notify aerosol fire suppression systems
③ Serial relay	Control system
④ Terminal line	For connecting cables
⑤ Switching Mode Power Supply	Power source
⑥ Terminal line	For connecting cables
⑦ Miniature circuit breaker	Controlled power-on and power-off
⑧ Water immersion sensor	Check the BESS for water leakage
⑨ Terminal line	Connect external cables
⑩ Air inlet	When combustible gas is detected, the inlet will automatically pop out and need to be manually reset after use.

2.4.2 Battery Introduction

Battery Module



Battery Type	LiFePO4(LFP)
Nominal Voltage	51.2Vdc
Rated Capacity	100Ah
Rated Energy	5.12kWh
Nominal Charge/Discharge Current	100A
Peak. Discharge Current	125A
Charge Temperature	0~55°C
Discharge Temperature	-20°C~55°C
Storage Temperature	0°C~35°C
Ingress Protection	IP20
Dimension (W/D/H)	440*570*133mm
Weight Approximate	45kg

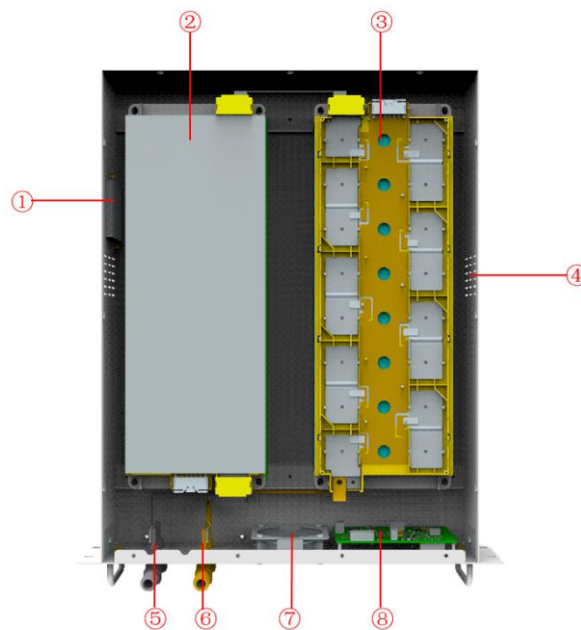

① Aerosol sensor	Detection of aerosol concentrations in the air
② Battery module	Provides electrical energy storage and output
③ CCS	Cells Contact System
④ Vent hole	Heat dissipation
⑤ Battery Negative-	/
⑥ Battery Positive+	/
⑦ Fan	Promote internal and external air flow
⑧ BMU	Battery monitoring

Power Distribution Unit



Operating Voltage	120~750Vdc
Nominal Charge/Discharge Current	100A
Max. Charge/Discharge Current	125A
DC Input Rating	12±2%V/4.15A
Operating Temperature Range	-20~65°C
Ingress Protection	IP20
Dimension (W/D/H)	440*570*150mm
Weight Approximate	19kg

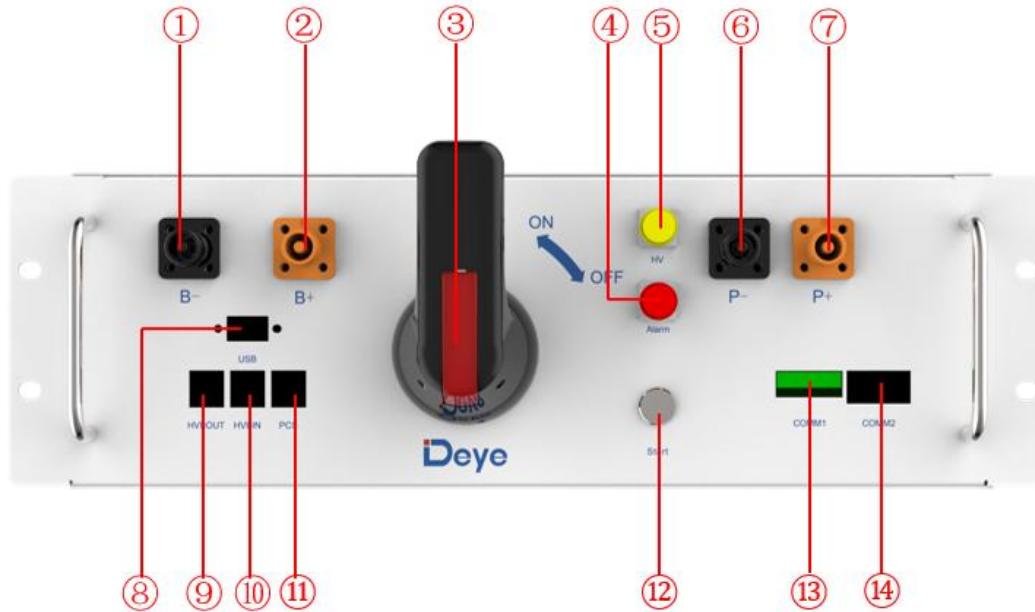

① B-	Connection position of the common negative pole of the battery
② B+	Connection position of the common positive pole of the battery
③ DC switch	Used to manually control the connection between the battery rack and external devices
④ ALRM light indicator	Battery system fault alarm indicator
⑤ HV light indicator	High-voltage hazard indicator
⑥ PCS-	Connection position of PCS negative pole
⑦ PCS+	Connection position of PCS positive pole
⑧ USB	BMS upgrade interface and storage expansion interface
⑨ OUT COM	Connection position with next GE-F-PDU communication output
⑩ IN COM	Connection position with previous GE-F-PDU communication input
⑪ PCS COM	Communication interface with charging and discharging equipment
⑫ START	A start switch of 12VDC power inside the high-voltage control box
⑬ COMM1	Communicative connection with the cabinet
⑭ COMM2	Communicative connection with the first battery module; and providing 12VDC power for the first battery module

2.4.3 Indicator light Design

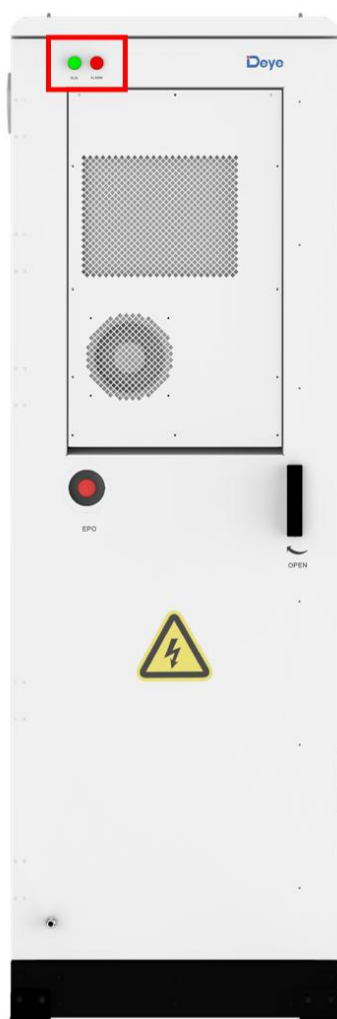

Indicator light: When the green light comes on, the BESS is Run. When the red light comes on, the BESS gives an alarm.

1. The following faults trigger either level 2 fault. The cabinet ALARM red light is on, the external ALARM light is on, and the RUN indicator is off.

1	System fault	17	Total voltage too high fault	33	Voltage acquisition fault
2	Charging current fault	18	Discharge relay adhesion	34	Temperature acquisition fault
3	Charging current fault	19	Charge relay adhesion	35	Emergency stop press fault
4	Charging overtemperature fault	20	Heating relay adhesion	36	Detected combustible gas fault
5	Discharging overtemperature fault	21	Extreme protection	37	Detected water sensor fault
6	Charging low temperature fault	22	Abnormal supply voltage	38	Detected smoke sensor fault
7	Discharging low temperature fault	23	Main positive relay adhesion	39	Pre-charge failed fault
8	Pressure difference	24	blown fuse	40	The Charging voltage is too

	too large fault				low
9	Temperature difference too large fault	25	BMU repeat fault	41	BMU communication fault
10	High SOC fault	26	BMU repeat fault	42	BMU number anomaly
11	Cell temperature low voltage fault	27	Internal CAN communication fails	43	Abnormal Mot total pressure collection
12	Pre-charge resistance temperature too high	28	PCS CAN Communication fails	44	Abnormal Temperature collection of the BMS connector
13	Insulation fault	29	Abnormal PCS RS485 communication	45	Abnormal Temperature collection of the BMU connector
14	Heating film is too high fault	30	Abnormal external total pressure collection	46	EEPROM storage fault
15	SOC too low fault	31	Abnormal internal total pressure collection	47	RTC clock fault
16	Total voltage too high fault	32	Abnormal SCHG total pressure collection	48	Current module fault
				49	Current acquisition fault

2. When the emergency stop press fault, flammable gas fault, water flooding fault and smoke fault are detected, the BESS external ALARM light is on and the RUN light is off.

3. The air conditioner is offline, the BESS external ALARM light is on, and the RUN light is off.

4. The following faults occur in the air conditioner. The BESS external ALARM light is on and the RUN light is off.

1	High temperature alarm	9	Internal ambient temperature 1 fault	17	Inner coil temperature protection
2	Low temperature alarm	10	Internal ambient temperature 2 fault	18	Internal fan failure
3	High humidity alarm	11	Internal ambient humidity 1 fault	19	Internal fan communication fault
4	Low humidity alarm	12	Internal ambient humidity 2 fault	20	Internal fan overloaded fault
5	Electric heating protection	13	Inner coil temperature fault	21	External fan failure
6	Outdoor ambient temperature fault	14	Pressure sensor failure	22	External fan communication fault
7	Outer coil temperature fault	15	High exhaust temperature protection	23	External fan overloaded fault
8	Exhaust temperature fault	16	Outer coil temperature protection	24	Compressor startup failure
				25	Compressor communication failure



Indicator: Steady yellow indicates that PDU is working properly and the battery power circuit is closed. When the red light is on, PDU gives an alarm.

The following faults trigger any level 2 fault, the battery ALARM red light is on, the PDU ALARM light is on, and the HV indicator is off.

1	System fault	17	Total voltage too high fault	33	Voltage acquisition fault
2	Charging current fault	18	Discharge relay adhesion	34	Temperature acquisition fault
3	Charging current fault	19	Charge relay adhesion	35	Emergency stop press fault
4	Charging overtemperature fault	20	Heating relay adhesion	36	Detected combustible gas fault
5	Discharging overtemperature fault	21	Extreme protection	37	Detected water sensor fault
6	Charging low temperature fault	22	Abnormal supply voltage	38	Detected smoke sensor fault
7	Discharging low temperature fault	23	Main positive relay adhesion	39	Pre-charge failed fault
8	Pressure difference too large fault	24	blown fuse	40	The Charging voltage is too low
9	Temperature difference too large fault	25	BMU repeat fault	41	BMU communication fault
10	High SOC fault	26	BMU repeat fault	42	BMU number anomaly
11	Cell temperature low voltage fault	27	Internal CAN communication fails	43	Abnormal Mot total pressure collection
12	Pre-charge resistance temperature too high	28	PCS CAN Communication fails	44	Abnormal Temperature collection of the BMS connector
13	Insulation fault	29	Abnormal PCS RS485 communication	45	Abnormal Temperature collection of the BMU connector
14	Heating film is too high fault	30	Abnormal external total pressure collection	46	EEPROM storage fault
15	SOC too low fault	31	Abnormal internal total pressure collection	47	RTC clock fault
16	Total voltage too high	32	Abnormal SCHG total	48	Current module fault

	fault		pressure collection		
				49	Current acquisition fault

3 Transport and storage

3.1 Transportation

1 Preventive Measures

Failure to ship and store products in accordance with the requirements of this manual may void the warranty.

2 Mode of Transportation

It can be transported by cars, trains and ships.

3.2 Transportation Requirement

The following conditions should be met for the transportation of BESS:

- Ensure that the door is locked.
- Select appropriate crane or lifting tool according to the site conditions. The lifting tool used shall have a sufficient load bearing capacity, boom length and radius of rotation.
- Additional traction may be required if ESS needs to be transported on slopes.
- Remove all obstacles that exist or may exist on the way, such as tree branches, cables, etc. The BESS should be transported and moved under good weather conditions.
- Be sure to set up warning signs or warning area to prevent non-staff from entering the lifting area to avoid accidents.
- When transporting by road, it is important to use ropes to secure the top ring of the equipment to the transport vehicle to avoid excessive tilt during transportation.

The battery products should be transported after packaging and during the transportation process, severe vibration, impact, or extrusion should be prevented to prevent sun and rain. It can be transported using vehicles such as cars, trains, and ships.

Always check all applicable local, national, and international regulations before transporting a Lithium Iron Phosphate battery.

Transporting an end-of-life, damaged, or recalled battery may, in certain cases, be specially limited or prohibited.

The transport of the Li-Ion battery falls under hazard class UN3480, class 9. For transport over water, air and land, the battery falls within packaging group PI965 Section I.

Use Class 9 Miscellaneous Dangerous Goods and UN Identification labels for transportation of lithium-ion batteries which are assigned Class 9. Refer to relevant transportation documents.



Class 9 Miscellaneous Dangerous Goods and UN Identification Label

3.3 Storage requirement

- During the rainy season to prevent possible condensation or its bottom being soaked by rain.
- BESS should be stored on higher ground. Raise container bases based on site conditions. The specific height should be reasonably determined according to the geological and meteorological conditions of the site.
- Stored on dry, flat, stable ground with sufficient carrying capacity and without any vegetation cover.
- The ground must be flat and dry. Before storage, ensure that BESS's door is locked.
- Storage ambient temperature: $-30^{\circ}\text{C}\sim 60^{\circ}\text{C}$, recommended storage temperature: $-30^{\circ}\text{C}\sim 25^{\circ}\text{C}$.



Notice! : To ensure battery life, keep the storage temperature of the battery module between 0°C and 35°C

- Storage If the battery energy storage system is not used for a long time, please refer to the following table to save power. After charging is complete, turn off all switches of the battery energy storage system to ensure the lowest power consumption of the system.
- The relative humidity should be between 0 and 95% without condensation.
- The inlet and outlet of BESS should be effectively protected to prevent rain, sand and dust from penetrating into. Check equipment regularly for damage.

4 Mechanical Installation

4.1 Inspection Before Installation

4.1.1 Open the package

- i. Find a claw hammer(or flat head screwdriver) to pry open the nail (refer to the following picture to operate).



ii. Pry it open and hammer it flat.

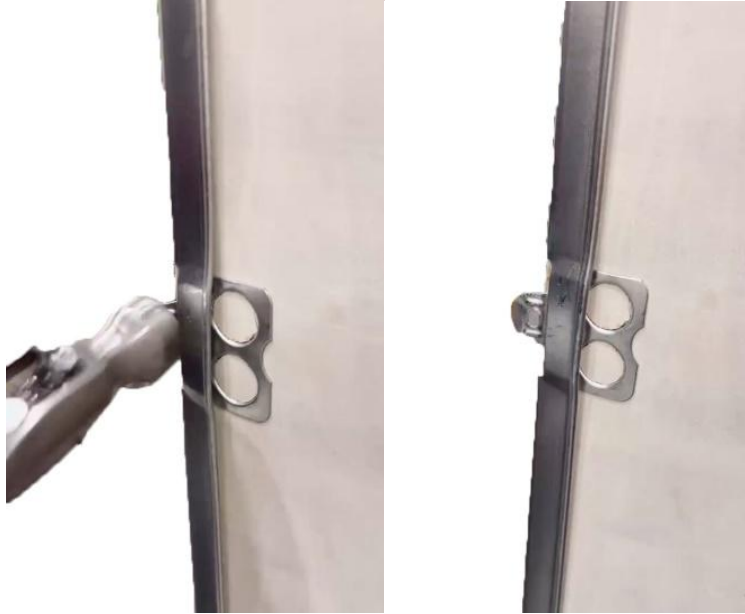

iii. First, pry out all the nails, then disassemble the top plate, and disassemble the surrounding plate.

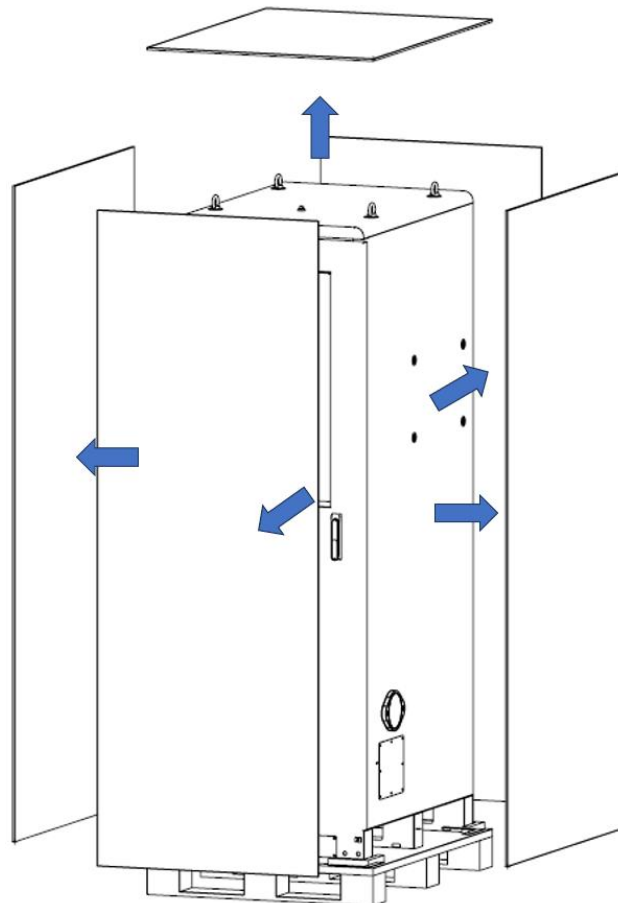

iv. Unscrew the two forklift protection plates at the bottom of the cabinet.

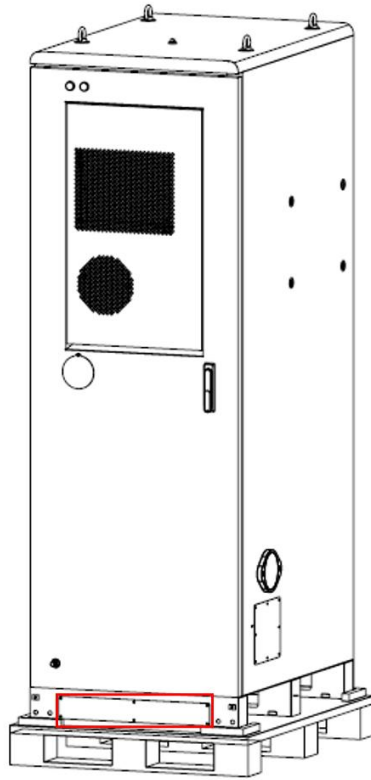

v. Unscrew the front and back four fixing screws, you can use the forklift truck transport.

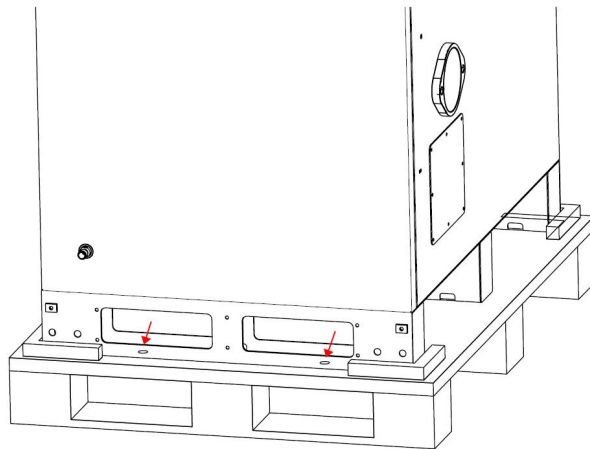

4.1.1 Deliverables Inspection

Check whether deliverables are complete against the packing list.

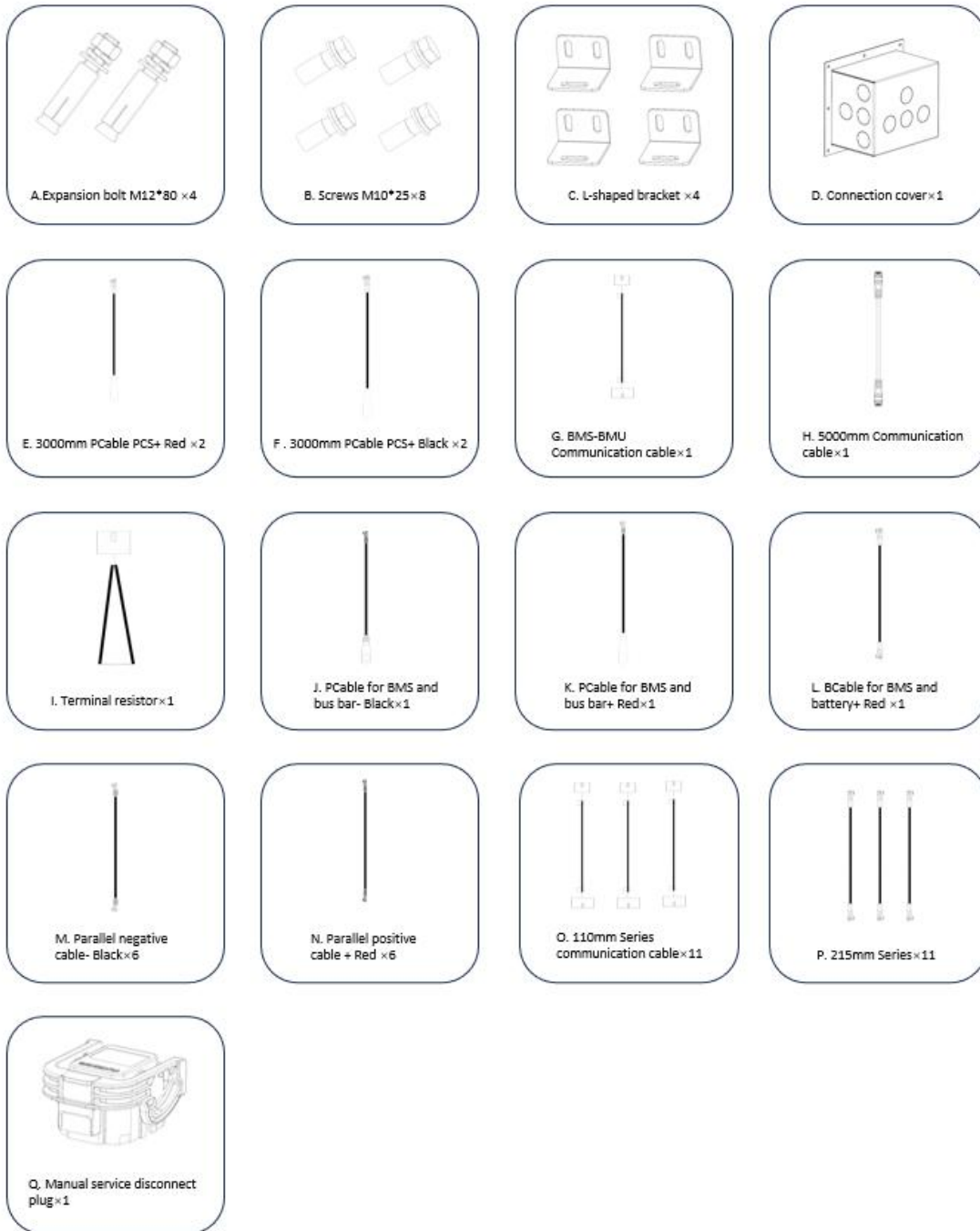

4.1.2 Product Inspection

Check BESS and internal equipment for damage. If you find any problems or have any questions, please contact the agency or Deye ESS.

4.2 Installation Environment

- The environment around the installation site should be dry and well-ventilated.
- The installation site should be far away from the concentration of toxic and harmful gases, and away from flammable, explosive and corrosive materials.
- The installation site should be far away from residential areas to avoid noise.

Installation site requirements

Unreasonably constructed foundation will bring great troubles to the installation of the BESS, affecting the normal opening and closing of the doors and the normal operation. Therefore, the foundation of the BESS must be designed and constructed according to certain standards to meet the requirements of mechanical support, cable routing and later maintenance and overhaul. **At least the following requirements shall be met during foundation construction:**

- The soil at the installation site should be compact.
- Compact and fill the foundation pit to provide sufficient and effective support for the cabinet.
- Raise the foundation to prevent the cabinet base and the interior from rain erosion.
- The cross-sectional area and height of the foundation should meet the requirements. It is recommended that the base height be greater than or equal to 300mm.
- Construct corresponding drainage in conjunction with local geological conditions.
- Build drainage systems according to local geological conditions.
- The foundation height is determined by the construction party according to the site geology.
- Consider cable routing when building the foundation.
- Built a maintenance platform around the foundation to facilitate later maintenance.
- During the foundation construction, reserve enough space for the AC/DC side cable trench according to the position and size of the cable inlet and outlet holes of the BESS and PCS, and pre-embed the cable conduit.
- Determine the specifications and quantity of the perforating gun according to the model and quantity of the cables.
- A drainage system is necessary to prevent the bottom or internal equipment of the BESS from being soaked in water during the rainy season or during heavy rainfall.
- Both ends of all embedded pipes should be temporarily sealed to prevent impurities from entering and causing troubles to later wiring.
- After all cables are connected, cable inlet and outlet and connector should be sealed with fireproof mud or other suitable materials to prevent rodent access.

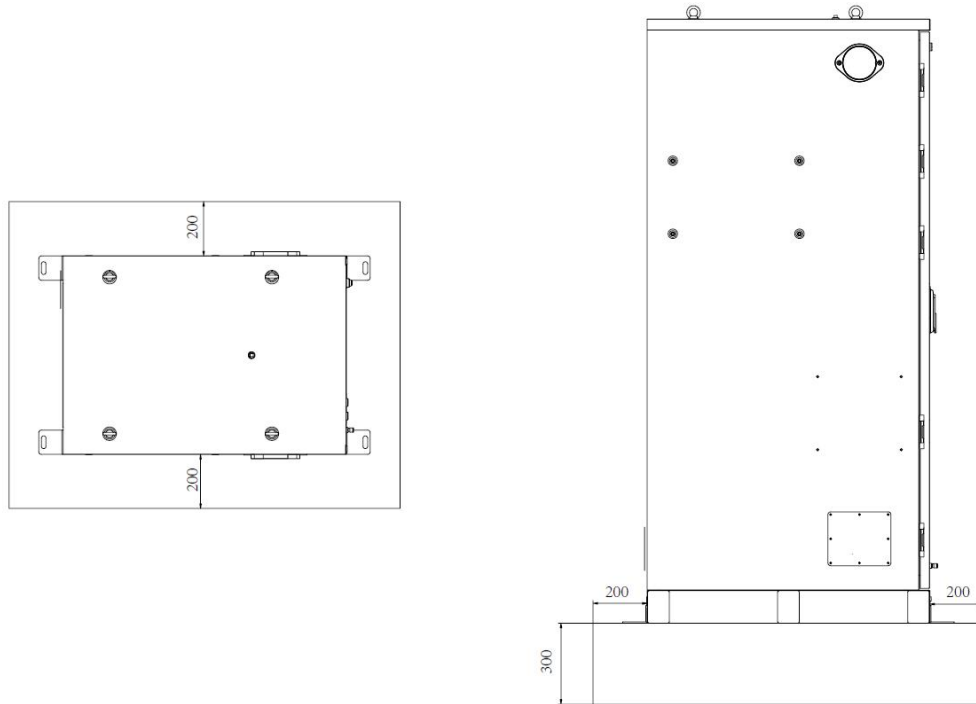

Foundation laying drawing (Unit: mm)



Notice! : The dregs excavated during the foundation construction should be removed immediately to avoid affecting the hoisting in the later stage.

4.3 Installation Spacing Requirement

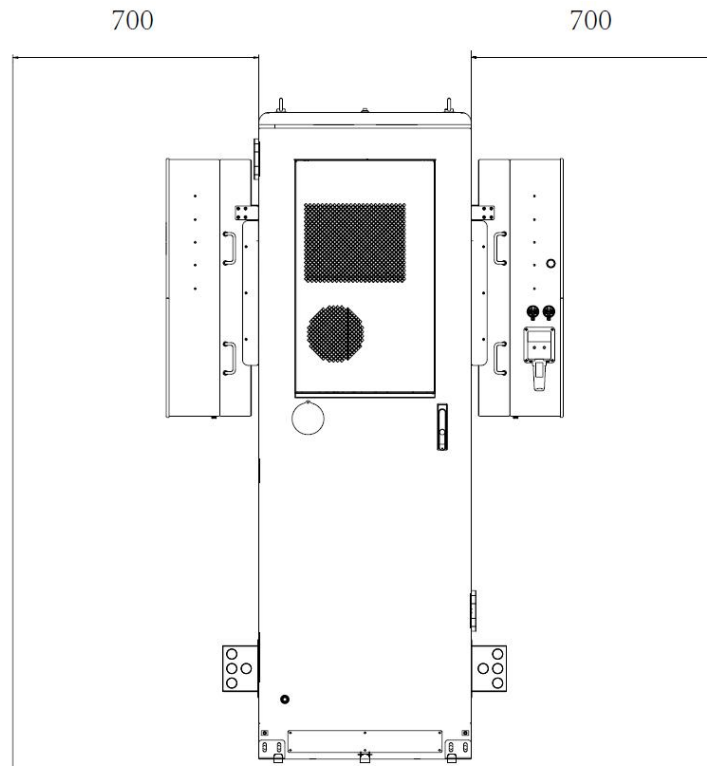

Installation spacing drawing 1 (Unit: mm)

Both sides of the inverter can be installed. But only needs to be installed on one side.



Notice! : If you want to install an inverter, reserve 700mm on the inverter installation side.

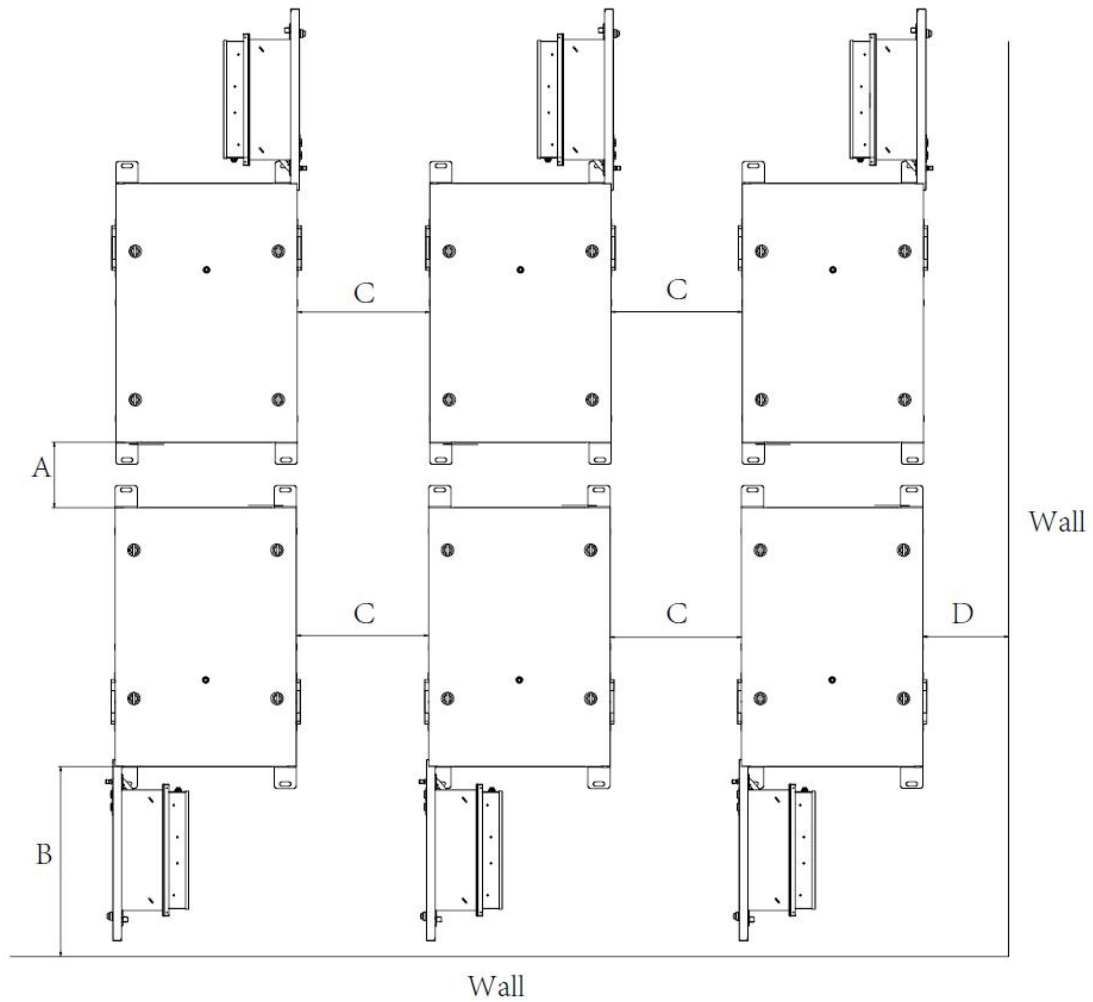

Installation spacing drawing 2 (Unit: mm)

Serial number	Distance
A	200
B	750
C	200
D	700

4.4 Installation of inverters and BESS

First remove the M12 screws on the BESS with the wrench of the M12 and install the inverter rack on the BESS.

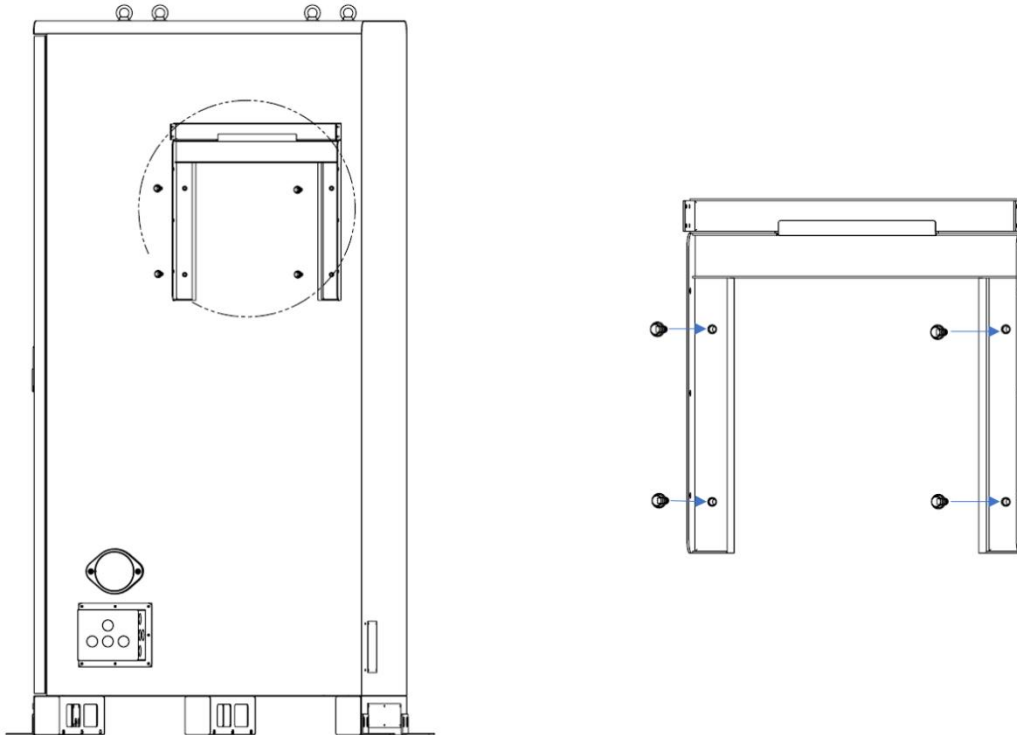

Second fix the inverter on the rack, and drive three screws on each side with a phillips screwdriver to complete the installation.

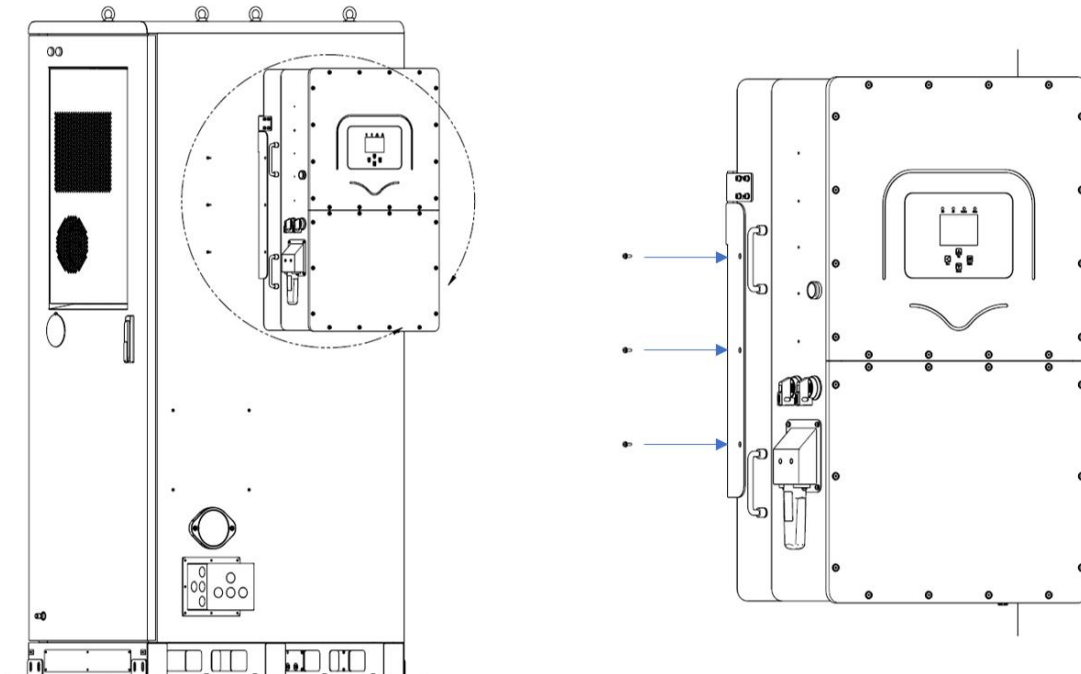

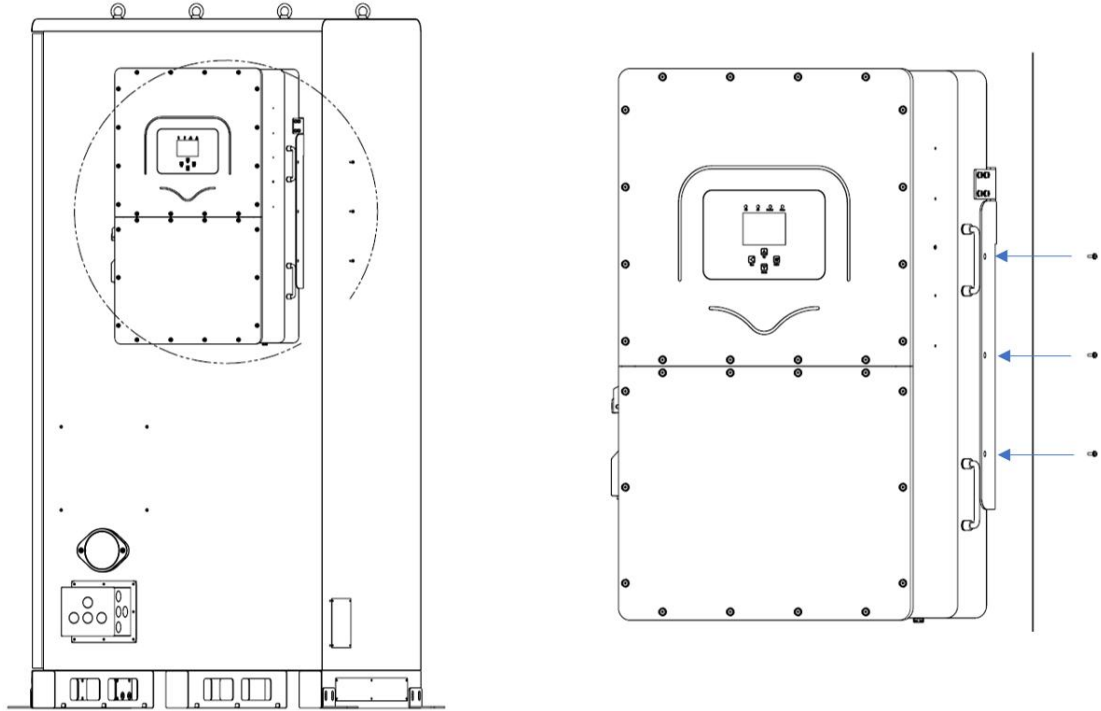

4.5 Transportation and lifting

4.5.1 Transportation

Forklift Transport If the installation site is flat, use a forklift to move the equipment. The bottom of the machine has a special forklift transport fork hole. A forklift with a rated load of more than 1500kg should be used.

Sugget to insert the forklift tooth in the location indicated below. The center of gravity is indicated in the diagram. Sugget to follow the safety precautions of forklift trucks.

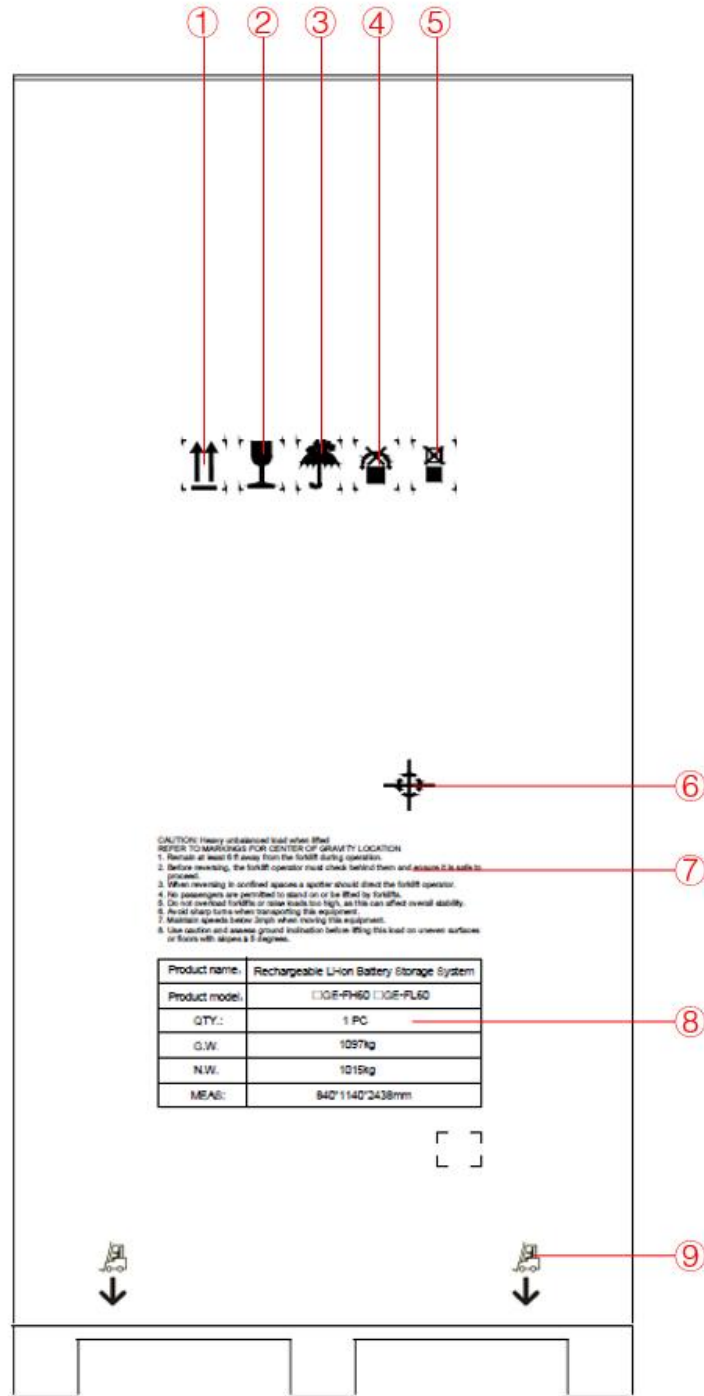

CAUTION: Heavy unbalanced load when lifted.
REFER TO MARKINGS FOR CENTER OF GRAVITY LOCATION.
 1. Remain at least 6 ft away from the forklift during operation.
 2. Before reworking, the forklift operator must check behind them and **avoid the load** in process.
 3. When reworking in confined spaces a spotter should direct the forklift operator.
 4. No passengers are permitted to stand on or be lifted by forklifts.
 5. Do not overload forklifts or raise loads too high, as this can affect overall stability.
 6. Avoid sharp turns when transporting this equipment.
 7. Maintain speeds below 5 mph when moving this equipment.
 8. Use caution and assess ground condition before lifting this load on uneven surfaces or floors with slopes > 3 degrees.

Product name:	Rechargeable Li-Ion Battery Storage System
Product model:	130E-FH60 130E-FL60
QTY:	1 PC
G.W:	1057kg
N.W:	1015kg
MEAS:	842*1140*2438mm

①	Wooden case should be placed face up
②	Fragile
③	Product should be stored against moisture
④	Prohibit to turn over product packaging during operation
⑤	Prohibit to stack
⑥	Center of gravity location
⑦	Forklift safety precautions
⑧	Product information
⑨	Forklift fork insertion position

If a forklift is used, the following requirements must be met: The forklift should be equipped with sufficient load capacity. The foot length of a forklift truck should meet the equipment requirements.

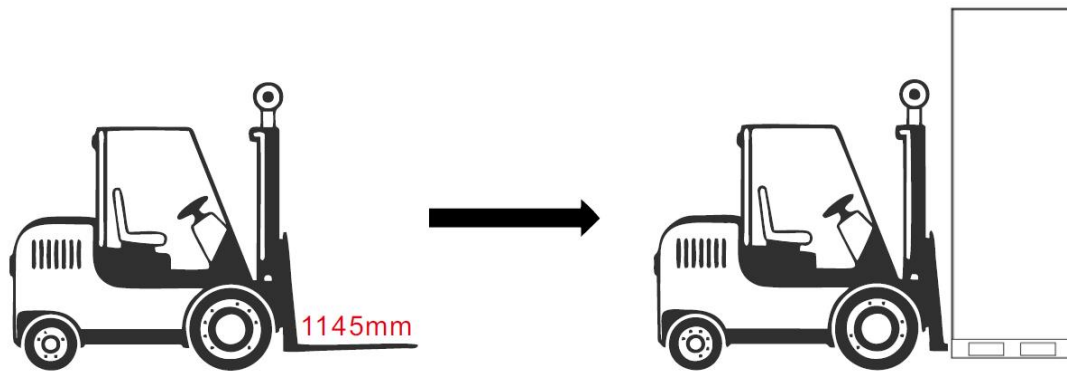

Caution! : Heavy unbalanced load when lifted
REFER TO MARKINGS FOR CENTER OF GRAVITY LOCATION



Notice!

1. Remain at least 6 ft away from the forklift during operation.
2. Before reversing, the forklift operator must check behind them and ensure it is safe to proceed.
3. When reversing in confined spaces a spotter should direct the forklift operator.
4. No passengers are permitted to stand on or be lifted by forklifts.
5. Do not overload forklifts or raise loads too high, as this can affect overall stability.
6. Avoid sharp turns when transporting this equipment.
7. Maintain speeds below 3mph when moving this equipment.
8. Use caution and assess ground inclination before lifting this load on uneven surfaces or floors with slopes ≥ 5 degrees.

4.5.2 Hoisting Equipment



Warning! :

Comply with crane safety procedures at all times.

Do not stand within 500-1000mm of the lifting area! During the whole lifting process, no one is allowed to stand under the boom or the work station.

The lifting work must be stopped in bad weather. For example, in the case of strong winds, heavy rain or thick fog.

When hoisting, a 25-ton crane should be used, and the lifting arm is required to be about 38.5 meters to 40.5 meters.

When lifting the device, at least the following requirements must be met:

- All safety requirements must be met.

- A professional instructor is needed in the whole hoisting process.
- The strength of the sling used should be able to withstand the weight of the devices.
- Ensure that all sling connections are safe and reliable, and that the lengths of the slings connected to the corner fittings are equal.
- The length of the sling can be adjusted appropriately according to the actual requirements of the site.
- During the lifting process, the devices must be stable and not skewed.
- Please lift the devices from the bottom.
- Take all necessary auxiliary measures to ensure the safe and smooth lifting of the devices.

The following figure shows the crane operation during lifting the devices. In the figure, the dashed circle on the inner layer represents the crane operating range. When the crane is working, it is strictly forbidden to stand inside the solid circle on the red outer layer!

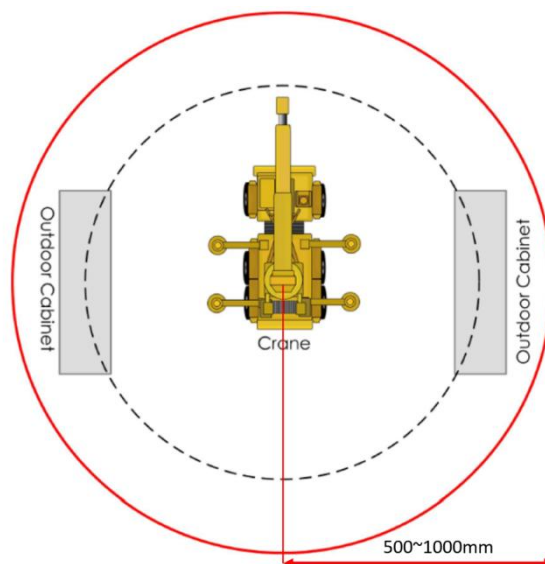

4.5.3 Hoisting

In the process of lifting the devices, each operation link should be carried out according to the following requirements:

- The equipment should be hoisted vertically and should not be dragged on any surface during hoisting.
- Check the connection between the lifting tool and the device before hoisting.
- Only lift it after confirming that the connection is secure. Once in place, the device should be gently and smoothly lowered. Do not place the device vertically and do not shake the lifting tools.
- The place where the devices are placed should be solid and flat, with good drainage, without obstacles or protrusions.

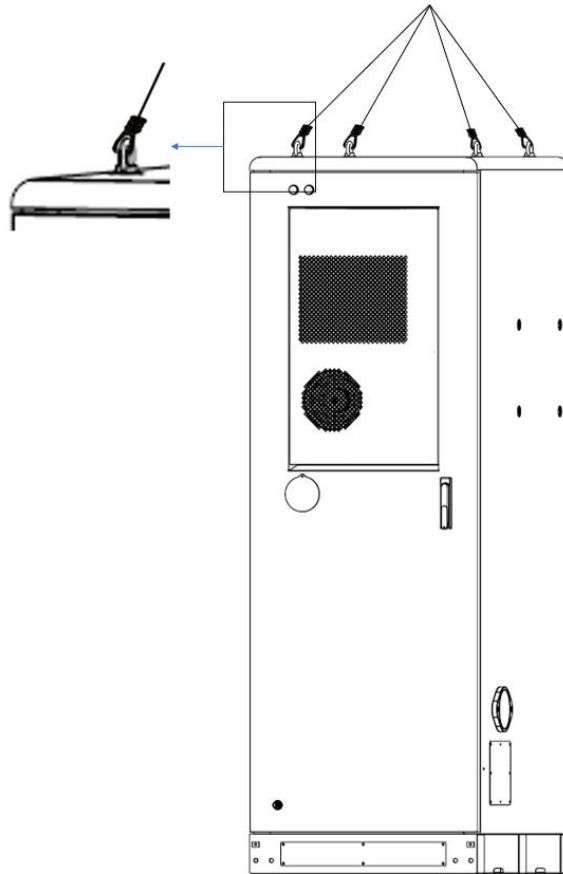

4.6 Fixing Methods

Fixed by L-angle steel

The following figure shows the positions for fixing the cabinet bottom using L-shaped Angle steel.

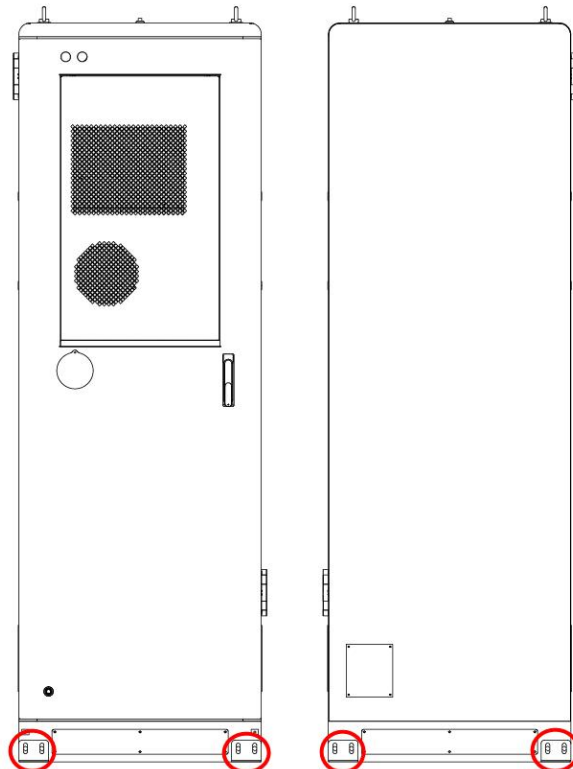

Fix the L-shaped Angle steel to the cabinet first, and then drive the expansion screws to fix the ground.

Use screws (M10*30) with torque (30N·m) above and use expansion screw(M12*80) to fix the bolt angle. Due to the uncertainty of drilling accuracy and bit material, it is recommended to choose a drill bit from $\phi 16.5$ to $\phi 17$.

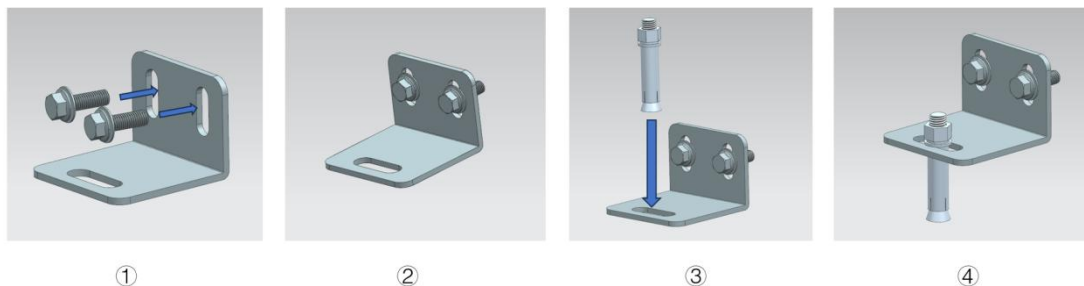

5. Electrical connection



Notice! : High voltage! Shock!

Do not contact live parts directly without protection!

Before installation, ensure that there is no voltage on the AC side and DC side.

Do not place the BESS on a flammable surface.



Warning!

Sand and moisture infiltration can damage the electrical equipment in the container or affect its operating performance! Do not perform electrical connections during sandstorms or when the relative humidity of the surrounding environment is greater than 95%. Make electrical connections when there is no wind or sand and when the weather is clear and dry.

Before connecting cables, check that the polarity of all input cables is correct. Do not pull wires and cables forcibly during electrical installation. Otherwise, the insulation performance may be affected. Make sure all cables and wires have enough room to bend. Take necessary auxiliary measures to reduce the stress on cables and wires. After each connection is complete, carefully check whether the connection is correct and secure.

5.1 Electrical connection Overview



Warning!







All electrical connections must be made in strict accordance with the wiring schematic.

All electrical connections must be made when the equipment is completely powered off.

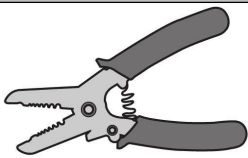
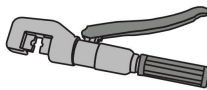
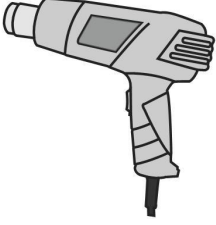
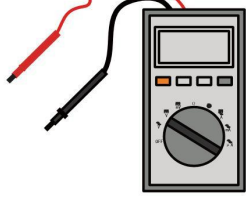
Only qualified electrical engineers can carry out work related to electrical connections. Please comply with the requirements in "1 Safety Precautions" of this manual. The Company shall not be liable for any injury or loss of life or property caused by ignoring these safety instructions.

5.2 Preparation before connection

Installation preparation tool

Item	Name and Graphics		
Installation tool	 Torque screwdriver	 Wire stripper	 Hydraulic pliers
	 Heat gun	 Multimeter	 Torque wrench
Protective tools	 Safety gloves	 Goggles	 Safety shoes
	 Protective clothing		

Opening mode

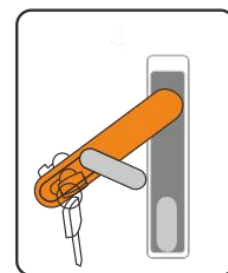
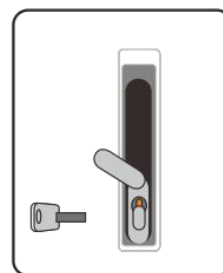
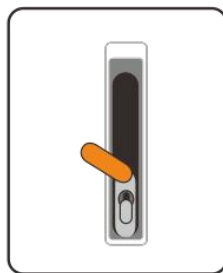
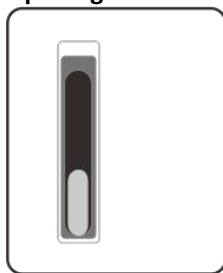

Opening procedure

1. Locked State
2. Move the cover above the keyhole upward

3. Insert the door key and turn it clockwise to eject the handle
4. Turn the handle clockwise to the position shown in the picture to open the front door.



Caution! : Please take care to lift this part when closing the door.

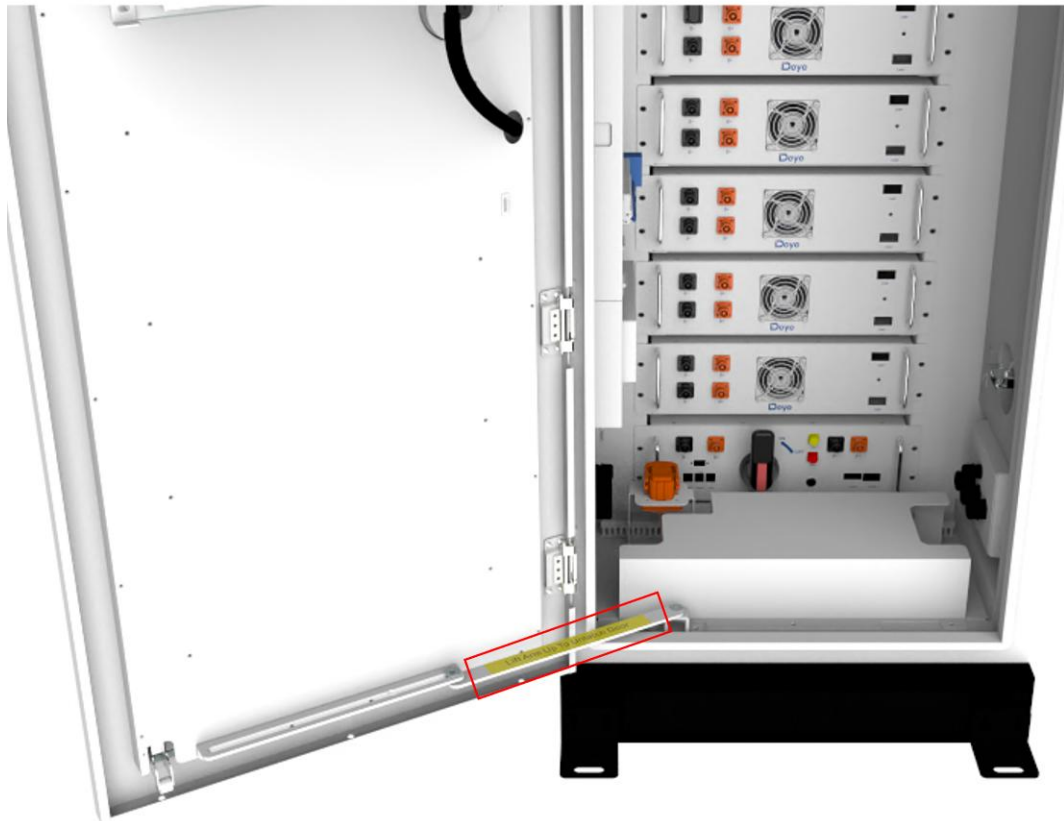

5.4 Cable connection



Notice! : infrequently used terminal please cover with dust cover protection.

5.4.1 Cable connections inside BESS

Parallel mode

Power cable connection: The battery module uses six **N.Parallel positive cable- Red** and six **M.Parallel negative cable- Black** in parallel. Five **P.215mm Series** are used to connect battery modules in series. And use one **L.BCable for BMS and battery+ Red** to connect the battery module to the PDU.

Communication cable connection: **O.110mm Series communication cable** is used to connect the battery module to the battery module, and **G.BMS-BMU communication cable** is used to connect the battery module to the PDU. Note the directions of DI and DO on the communication line. Do not insert by mistake.

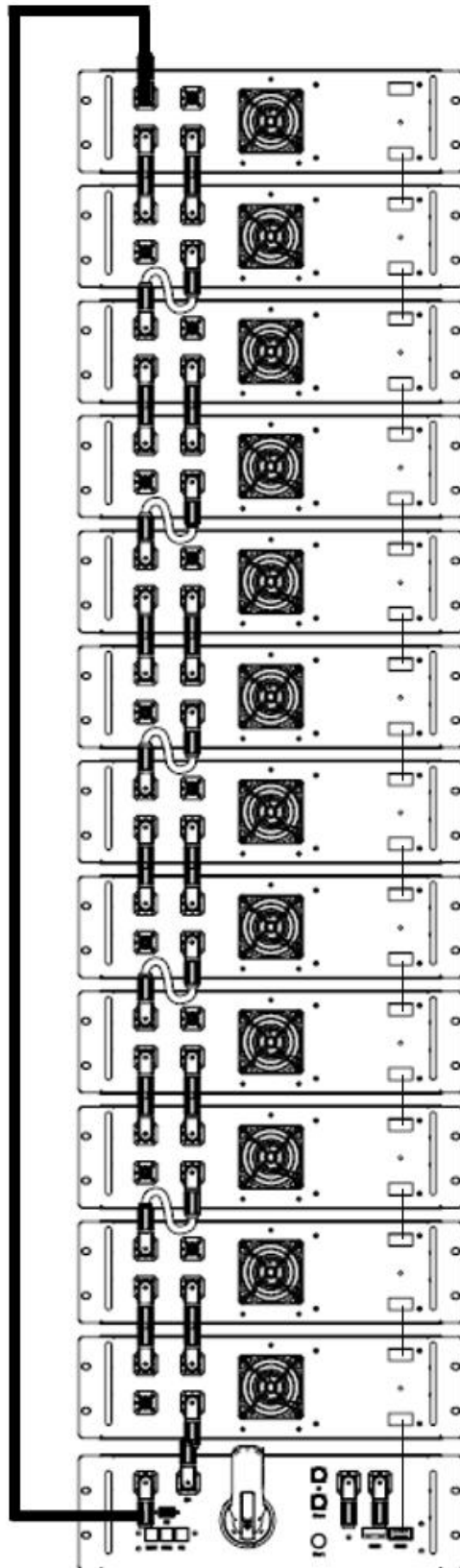

Danger!

Wrong connection mode: Please do not connect as follows!

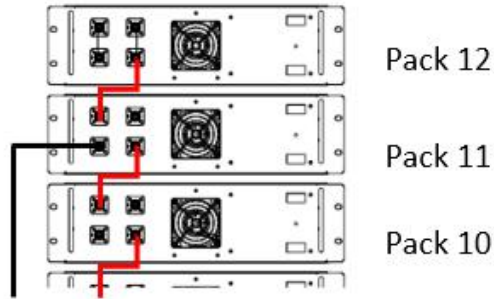

Wrong connection mode 1

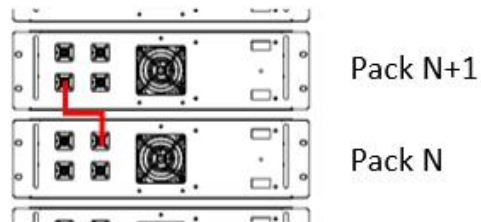

Wrong connection mode 2

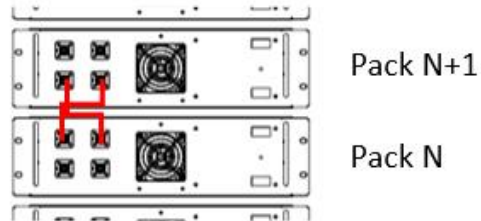

Wrong connection mode 3

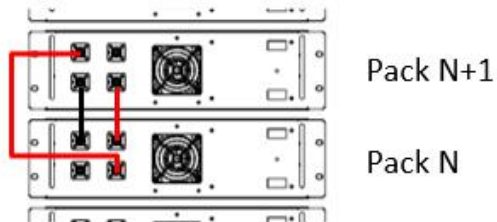

Wrong connection mode 4

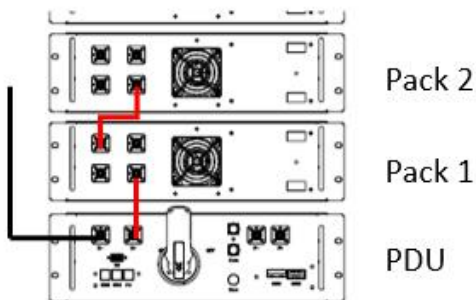

Wrong connection mode 5

5.4.2 Auxiliary power supply

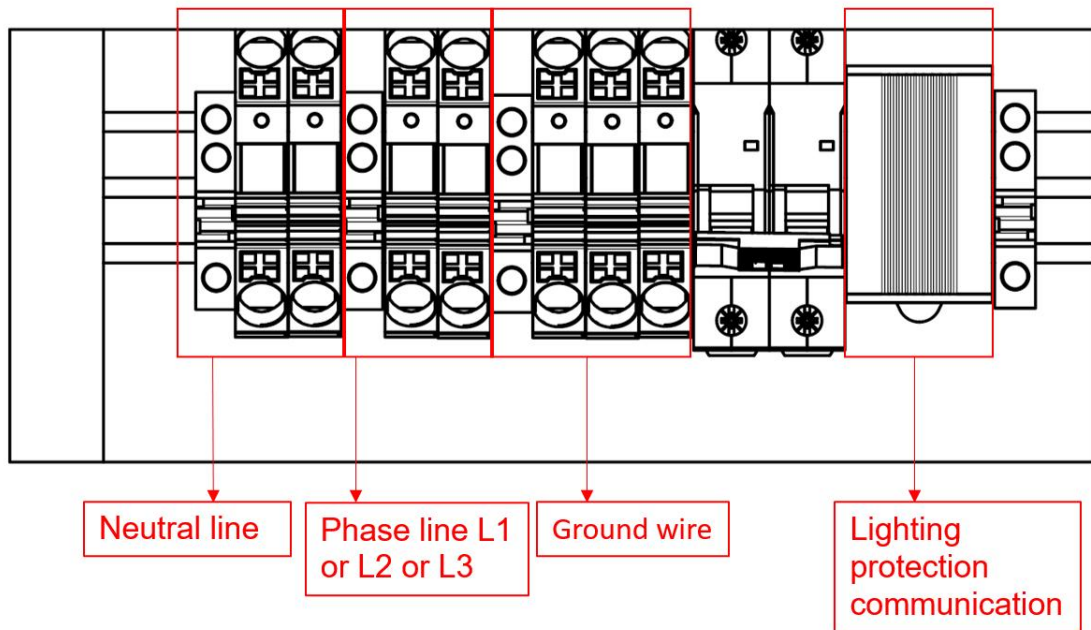

Ground wire requirements $> 12\text{AWG}$

Neutral line and Phase line L1 or L2 or L3 requirements 1 BESS $\geq 12\text{AWG}$

2 BESSs $\geq 10\text{AWG}$

3 BESSs $\geq 8\text{AWG}$

4 BESSs $\geq 7\text{AWG}$

5 BESSs $\geq 6\text{AWG}$

6 BESSs $\geq 5\text{AWG}$

Lighting protection communication use **Connected to external device communication cable (ECOM Cable 5.0)**

Auxiliary distribution diagram

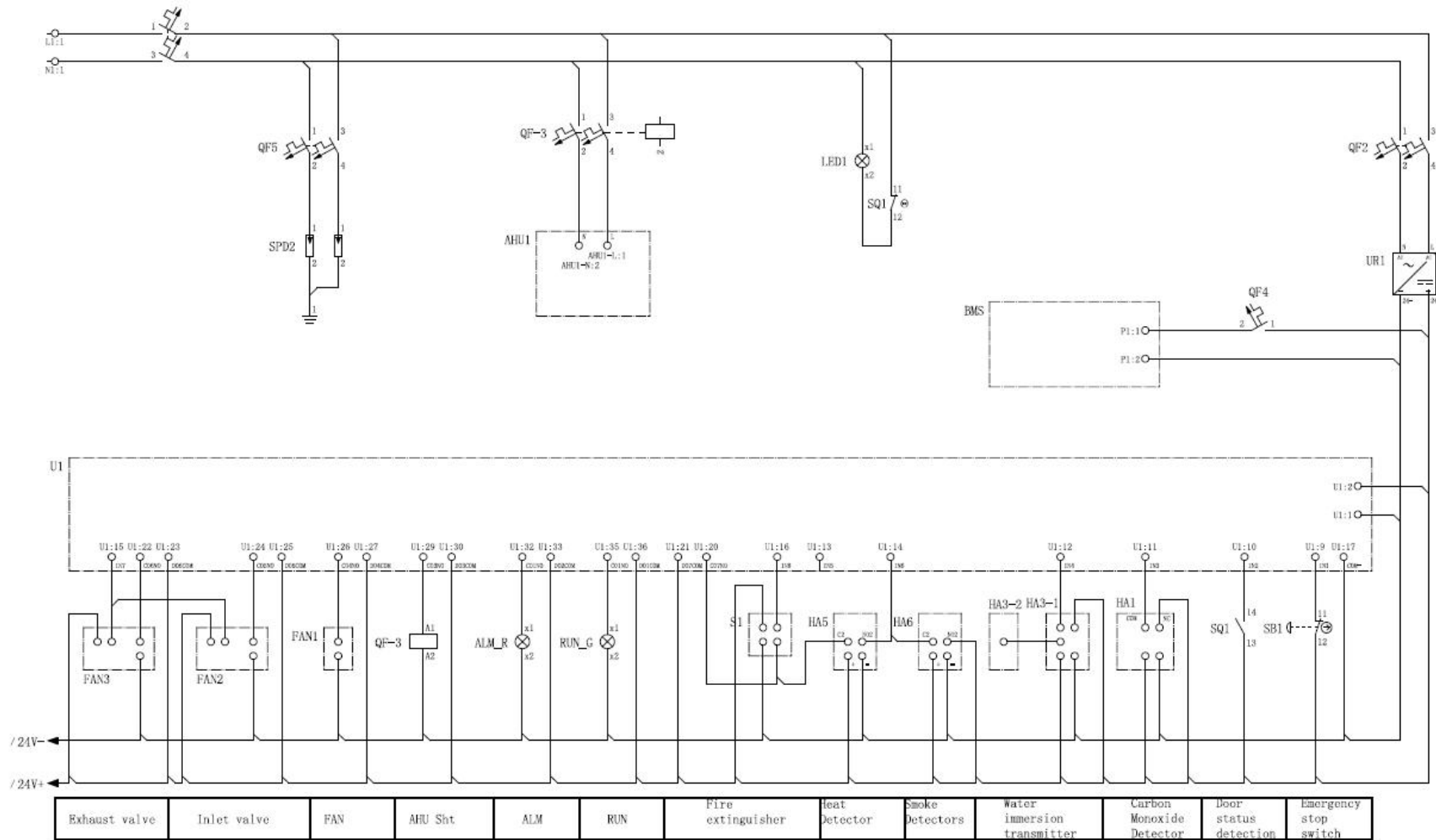

Auxiliary power supply diagram

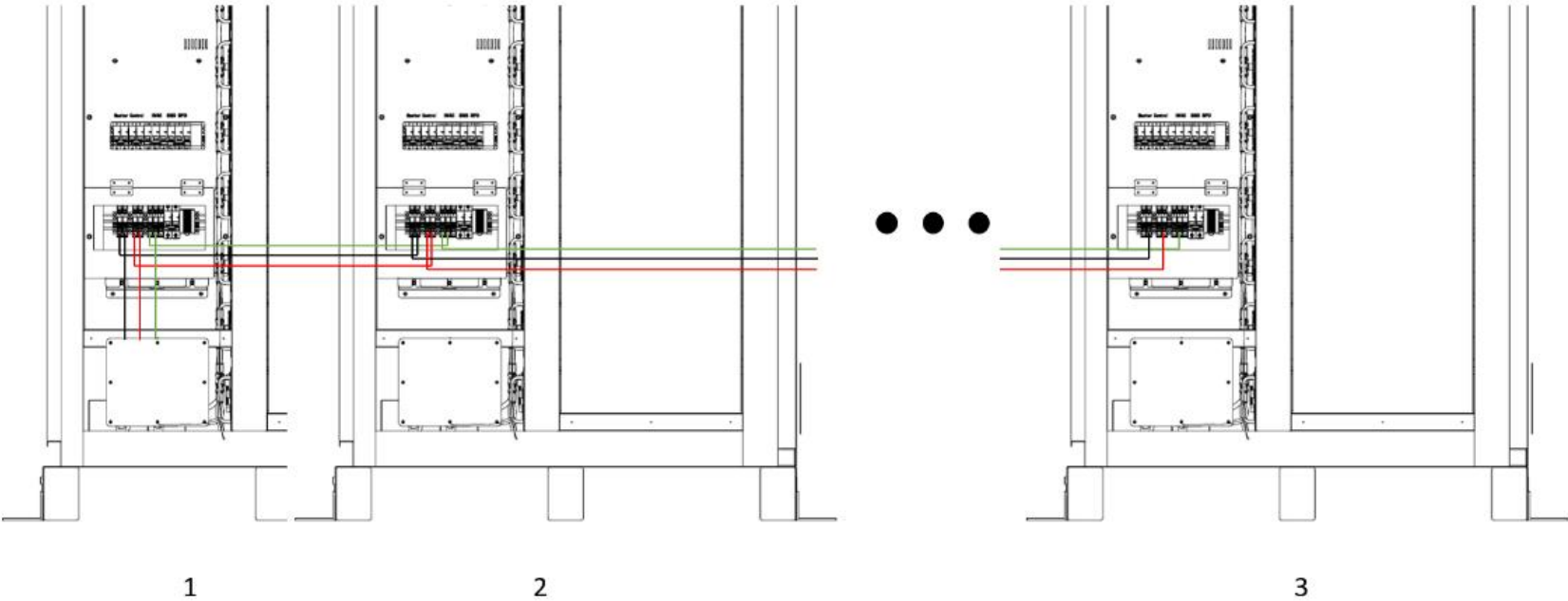
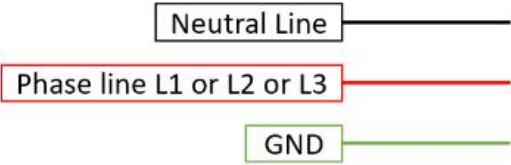

5.4.3 Cable connection between BESS

It can be connected to one to six BESS.

It is recommended that each BESS be connected to power distribution separately. If the power distribution is not connected separately, follow the method recommended by Deye ESS.

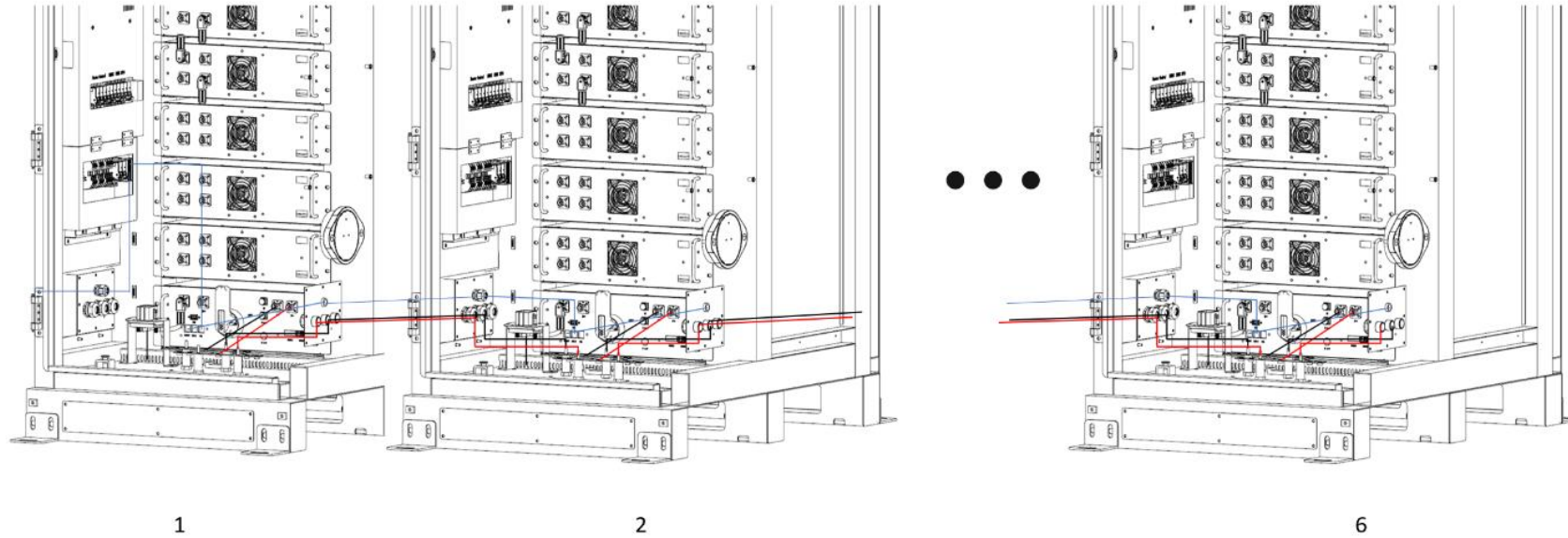
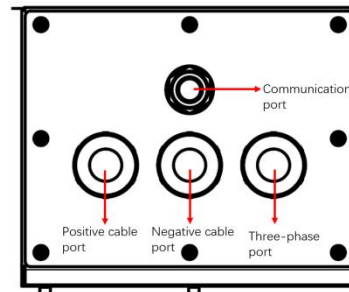

(Note: Other cables are also connected, which is not shown in the drawing)

5.4.4 Cable connection between the inverter and BESS

Open the cabinet door and connect according to the following figure. The negative copper bar is connected to the PDU P- and the negative electrode of the inverter. The positive copper bar is connected to the PDU P+ and the negative electrode of the inverter. Connect one end of the communication cable to the lightning protection communication (blue frame) through the cabinet, and connect the other end to the inverter CAN .

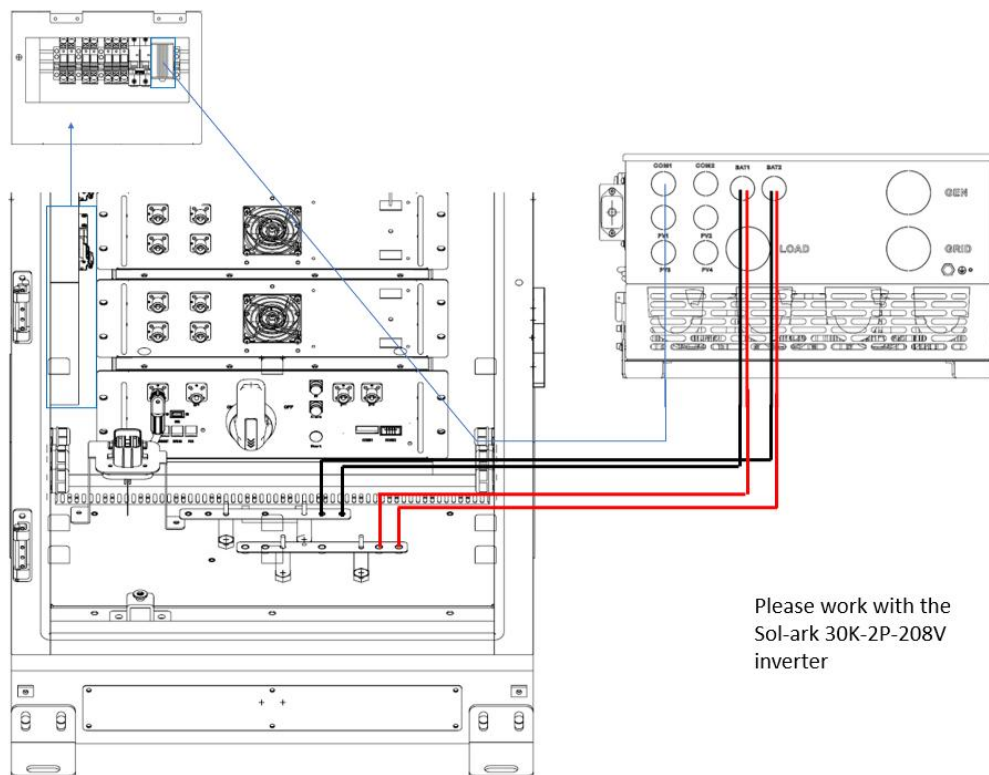

(Note: Other cables are also connected, which is not shown in the drawing)

5.5 Operation after cable connection

When all electrical connections are complete, check the wiring thoroughly and carefully. In addition, you need to do the following:

- Check all air intakes and outlets for blockage.
- Seal the gap around the cable inlet hole.



Warning!

- If improperly sealed, moisture may enter the product.
- If the product is not properly sealed, rodents may enter.

Lock the door operation

Procedure Step 1 Reinstall the cable protection cover in the reverse sequence.

Step 2 Lock the cabinet door, remove the key, and keep it secure.

— Take care to ensure that the seal around the cabinet door does not curl when the door is closed!

5.6 Battery Connection



Notice!

- When installing hazardous voltage equipment, comply with relevant regulations and local installation safety guidelines.
- Follow the rules for the proper use of tools and personal protective equipment.
- All connections must be made under clear guidance. Any attempt at speculation and ambiguity must be prohibited.
- Tools with an insulating protective coating must be used.

6 Activate BESS

Power on and off



Warning!

BESS needs to be confirmed by professionals and approved by the local power department before it can be put into operation.

For BESS with a long downtime, check the equipment thoroughly and carefully before powering on to ensure that all indicators are normal

Before powering on the device, check the following items:

- Check whether the wiring is correct.
- Check whether the emergency stop button is released.
- Check and confirm that there is no ground fault.
- Use a multimeter to check whether the AC voltage and DC voltage meet the starting conditions and ensure that there is no overvoltage.
- Check and make sure there are no left tools or parts inside the equipment.
- Check all air intakes and outlets for blockage.

6.1 Power-on procedure

After the cables are connected, connect the MSD

- ① Turn on the Miniature circuit breaker of MASTER, CONTROL, HVAC in turn.
- ② Open the Air switch
- ③ Press the Start button to turn on the PDU.
- ④ Open the miniature circuit breaker of the BMS

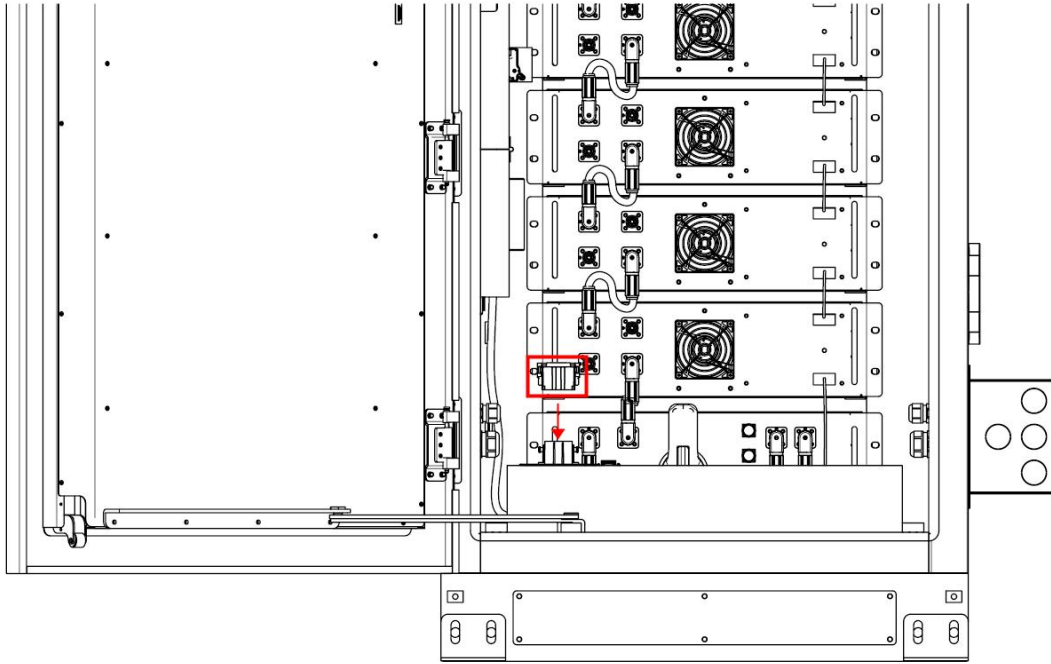

MSD connection diagram

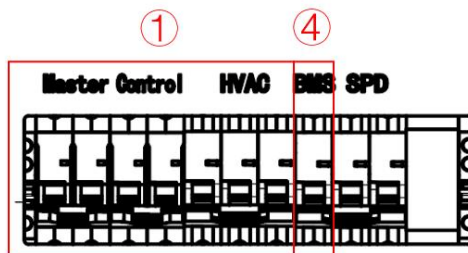
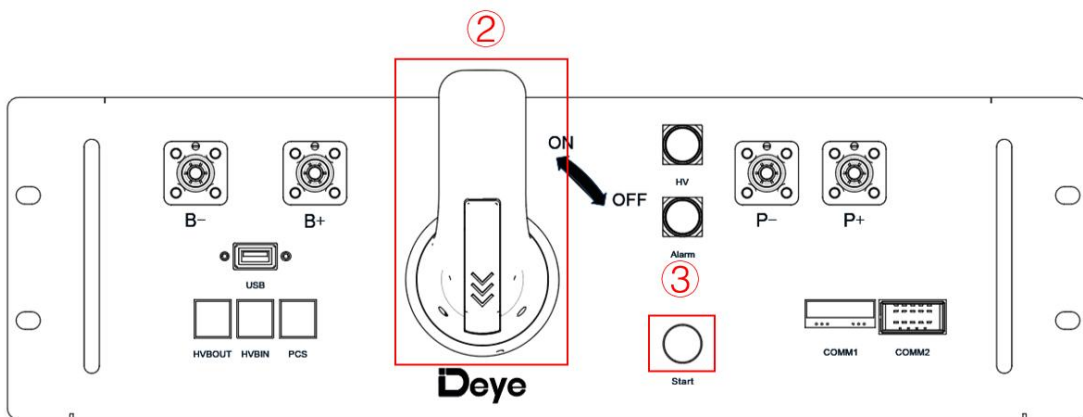

6.2 Power-off procedure

- ① First turn off the miniature circuit breaker of the BMS
- ② Press the Start button to turn off the PDU.
- ③ Close the Air switch
- ④ Turn off the Miniature circuit breaker of HVAC, CONTROL, MASTER in turn.

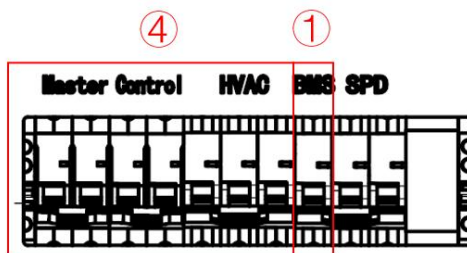
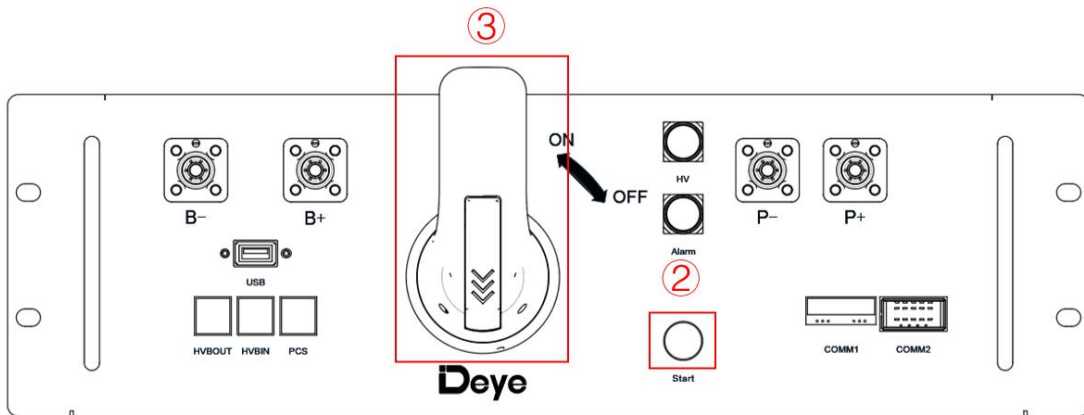

6.3 Unplanned (emergency) shut down

Fire incidents: Contact your local fire professional.
 Unplanned downtime (downtime due to failure) : Contact Deye ESS.

7 Fire Suppression system

7.1 Fire Suppression equipment



Caution!

The battery is equipped with fire suppression equipment

General rules:

Please comply with the fire laws and regulations of the country/region where the project is located.

Regular inspection and maintenance of fire suppressing equipment to ensure its normal operation.

7.1.1 Aerosol fire suppression system

The battery is lithium iron phosphate battery, and the equipment is equipped with an aerosol fire suppression system. It is also equipped with smoke detector and heat detector, and if anomalies are detected, the battery system will alarm and spray aerosols at the same time to stop the fire.



7.1.2 Fire suppression water pipe system





Notice! The temperature inside the BESS reaches 68 °C, and the red thermosensitive glass ball on the fire suppression water pipe explodes to spray water, fire suppression and cool the BESS



Notice! The recommended outer diameter of the water pipe to be installed is 1.315in and the inner diameter is 1.049in.

Single cabinet installation

When installing a single cabinet, you are advised to install an extension pipe (the length is based on customer requirements). Then install an elbow water pipe, and connect with the water source to complete the water pipe installation (installation direction according to customer requirements).

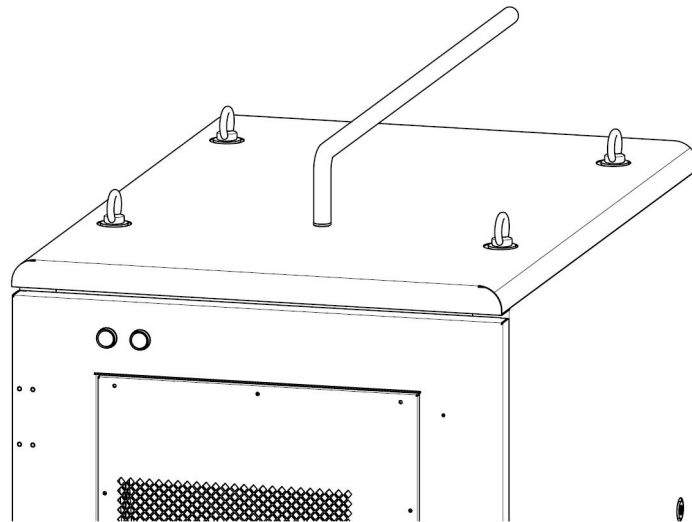

Multiply cabinet installation

When installing multiple cabinets, you are advised to install an extension pipe (the length is based on customer requirements). Then, install Tee-junction connectors, connect them to adjacent cabinets. Finally connect the water source (water source direction according to customer demand).

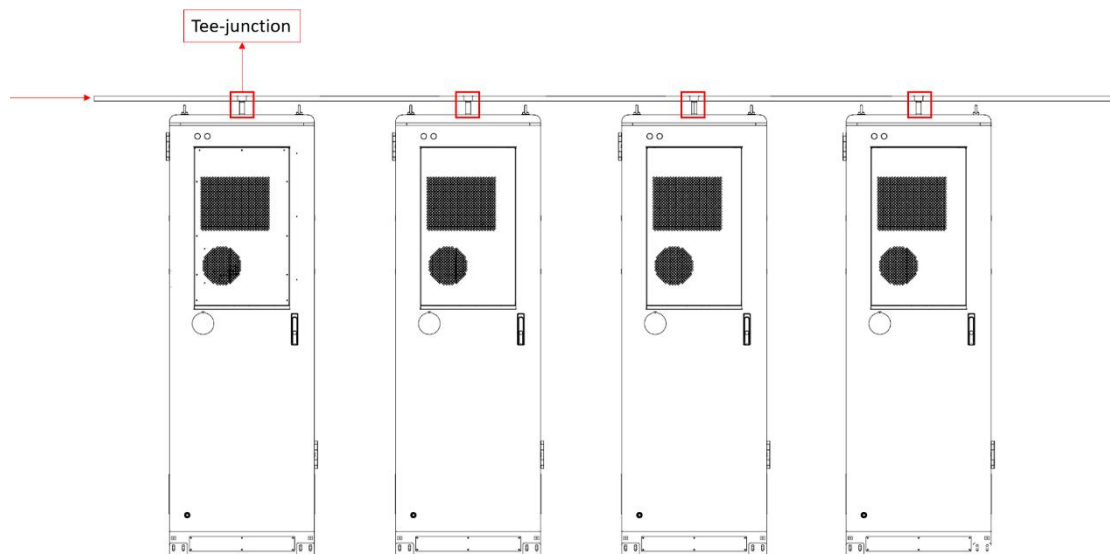



Danger! If the fire is too large, flee as soon as possible and call the fire police.

7.2 Exhaust system

When the ① **combustible gas detector** detects flammable gas in the housing, the ② **Air outlet** will pop out and exhaust the flammable gas.

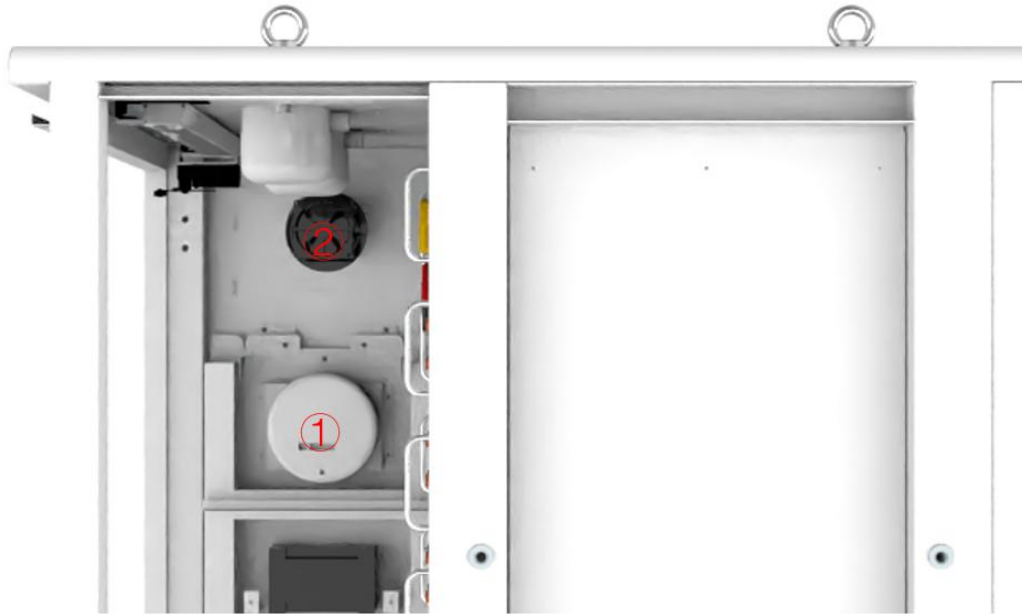

8 Troubleshooting

To determine the status of the battery system, users must use additional battery status monitoring software to examine the protection mode. Refer to the installation manual about using the monitoring software. Once the user knows the protection mode, refer to the following sections for solutions.

Fault Type	Fault Generation condition	Possible Causes	Troubleshooting
BMS fault	The cell voltage sampling circuit is faulty. The cell temperature sampling circuit is faulty	The welding point for cell voltage sampling is loose or disconnected. The voltage sampling terminal is disconnected. The fuse in the voltage sampling circuit is blown. The cell temperature sensor has	Replace the battery.

		failed.	
Electrochemical cell fault	The voltage of the cell is low or unbalanced.	Due to large self- discharge, the cell over discharges to below 2.0V after long term storage. The cell is damaged by external factors, and short circuits, pinpricks, or crushing occur.	Replace the battery.
Overvoltage protection	The cell voltage is greater than 3.65 V in charging state. The battery voltage is greater than 58.4 V.	The busbar input voltage exceeds the normal value. Cells are not consistent. The capacity of some cells deteriorates too fast or the internal resistance of some cells is too high.	If the battery cannot be recovered due to protection against abnormality contact local engineers to rectify the fault.
Under voltage protection	The battery voltage is less than 40V. The minimum cell voltage is less than 2.5V	The mains power failure has lasted for a long time. Cells are not consistent. The capacity of some cells deteriorates too fast or the internal resistance of some cells is too high.	Same as above.
Charge or discharge high temperature protection	The maximum cell temperature is greater than 60°C	The battery ambient temperature is too high. There are abnormal heat sources around	Same as above.
Charge low temperature protection	The minimum cell temperature is less than 0°C	The battery ambient temperature is too low.	Same as above.
Discharge low temperature protection	The minimum cell temperature is less than -20°C	The battery ambient temperature is too low.	Same as above.

9. Inspection and maintenance.

9.1 Basic Information

- The battery is not fully charged. It is recommended to complete the installation within 3 months after the arrival of goods.
- Do not disassemble any battery in the battery product, do not dissect the battery;
- After the battery is over-discharge, charge the battery within 48 hours. Battery products can also be charged in parallel. After the battery products are connected in parallel, the charger only needs to connect the output port of any product battery.
- Do not attempt to open or remove the battery! The battery contains no internal repairable parts.
- Before cleaning and maintaining the battery, disconnect all load and charging devices.

9.2 Maintenance item and period

Maintenance of equipment

Every half a year to once a year

Item	Check method
Safety function	<ul style="list-style-type: none"> • Check whether the shutdown key on the touchscreen and the emergency stop button work normally. • Simulate shutdown.
Internal components inspection	<ul style="list-style-type: none"> • Check the temperature of the radiator and the amount of dust accumulated. Clean heat-dissipation modules with a vacuum cleaner if necessary. <p>Notice: It is necessary to check ventilation of the air inlet. Otherwise, fault may occur due to overheating if the module cannot be cooled effectively.</p>
Device maintenance	<ul style="list-style-type: none"> • Carry out regular inspection for corrosion of all metal components • Check the running parameters (especially voltage and insulation).

Maintenance (Once a year)

Item	Check method
Outside the BESS	<p>Check the following items, and correct immediately those failing to meet relevant requirements:</p> <ul style="list-style-type: none"> • Check whether there are flammable objects on the top of the BESS. • Check whether there is any damage, flaking paint or sign of oxidization on the enclosure. • Check whether the lock of the cabinet door can be unlocked flexibly. • Check whether the sealing strip is fixed properly.
Inside the BESS	<p>Check whether there are foreign objects, dust, dirt, and condensed water inside the BESS.</p>
Air inlet and outlet	<p>Check the temperature of the radiator and the amount of dust accumulated. Clean heat-dissipation modules with a vacuum cleaner if necessary</p>
Wiring and cable layout	<p>Completely power off the devices inside the ESS before checking. For any non-conformances found during inspection, correct them immediately.</p> <ul style="list-style-type: none"> • Check whether the cable layout is normal and whether there is a short circuit. For any non-conformances found during inspection, correct them immediately. • Check whether all cable entry is well sealed. • Check whether there is water seepage inside the BESS. • Check whether the power cables are loose, and fasten them again by the torque specified previously. • Check whether the power cables and control cables are damaged, especially if the surface contacting the metal surface is cut. • Check whether the insulation tapes on the power cable terminals fall off.
Ground connection and equipotential	<ul style="list-style-type: none"> • Check whether the ground connection is correct and the grounding resistance shall be no more than 0.4Ω. • Check whether the equipotential connection inside the integrated

connection	BESS is correct.
Screw	Check whether internal screws fall off.

Every two years

Item	Check method
System status and cleaning	<p>Check the following items, and correct immediately those failing to meet the relevant requirements:</p> <ul style="list-style-type: none"> • Check whether there is any damage or deformation of the container and internal devices. • Check if there is abnormal noise during operation of internal devices. • Check whether the temperature in the container is excessively high. • Check whether the humidity and the amount of dust inside the container are within the normal range. Clean the equipment if necessary. • Check whether the air inlet and outlet of the BESS are blocked.
Warning marks	Check whether the warning labels and marks are clearly visible and free of stains and damage. Replace them if necessary.
Surge protection device and fuse	Check whether the SPD and fuse are properly fastened.
Corrosion	Check whether there is oxidation or rust inside the container.

9.3 Battery Maintenance

Below is the recommended maintenance cycle. The actual maintenance cycle should be adjusted according to the specific installation environment of this product. In sandy or dusty environments, it is necessary to shorten the maintenance cycle and increase the frequency of maintenance.

Once every six months

Inspection item	Inspection method
Ambient temperature and humidity inspection	<ul style="list-style-type: none"> • Check whether the temperature in the ambient temperature record is within the operating range. • Check whether the humidity in the ambient humidity record is within the operating range.
Function inspection	<ul style="list-style-type: none"> • Check the operating status of the DC contactor: Send the Start/Stop command in the power-off status and check whether the system works properly. • Measure whether the output voltage is within the range in the specification. • Check whether the current, voltage and temperature in the operation record of the battery cluster are within the operating ranges.

Once a year

Inspection item	Inspection method
Switchgear and	Please check the following items and take corrective action

battery module	<p>immediately if you find any non-conformity:</p> <ul style="list-style-type: none"> • Check the top of the battery cluster for combustibles. • Check whether battery clusters are fixed on the baseplate and corroded. • Check the box for damage, peeling paint, oxidation, etc. • Check the battery cluster for foreign bodies, dust, dirt, and condensate.
Wire and cable layout	<ul style="list-style-type: none"> • The inspection must not be carried out until all internal devices of the battery cluster are powered off! In case of nonconformity found in inspection, take corrective actions immediately: • Check the cable layout for short circuit and compliance with the specifications. If case of any abnormality, take corrective actions immediately. • Check whether all wire inlets and outlets of the battery cluster are sealed properly. • Check the battery cluster for internal seepage of water. • Check whether the power cables and copper busbars are loose, and tighten them according to the aforesaid torque. • Check the power cable and communication cable for damage, especially cut marks on the surface exposed to the metal surface.
Grounding	Check whether the grounding is correct. The grounding resistance should not be greater than 4Ω.
Fan	<ul style="list-style-type: none"> • Check the fan for faults (e. g. locked rotor and stalling). • Check the fan for abnormal noise during operation.
Screw	Check whether screws inside the battery cluster fall off or are rusted.

once every two years

Inspection item	Inspection method
Battery cluster status and cleanliness	<p>Check the following items. In case of nonconformity, take corrective actions immediately:</p> <ul style="list-style-type: none"> • Check the battery cluster and internal devices for damage or deformation. • Check the internal devices for abnormal noise during operation. • Check whether the temperature inside the battery cluster is too high. • Check whether the internal humidity and dust of the battery cluster are within the normal ranges. If necessary, clean the battery cluster. • Check whether the air inlet and outlet of the battery cluster are blocked.
Warning sign	Check whether the warning sign and label are legible and dirty. If necessary, replace them.
Wire and cable	Check whether the switch gear and battery module are connected correctly and whether the battery modules are also connected correctly.
Corrosion	Check the battery cluster for internal oxidation or rust.

To maintain the system safely and efficiently, maintenance personnel must carefully read and comply with the following safety requirements:

1. Hold the electrician certificate issued by the Safety Supervision Bureau, and take up the post after professional training.
2. Follow safety precautions, use necessary tools, and wear personal protective equipment.
3. Do not wear jewelry, watches and other metal jewelry.
4. Under no circumstances, do not touch the high pressure positive and negative poles of the energy storage system with both hands.
5. Before maintaining the energy storage system, turn off all high-voltage and low-voltage switches.
6. Do not wash the product directly with water. Use a vacuum cleaner if necessary.
7. Cables should be inserted and removed in accordance with regulations. Violent or brute force operations are prohibited.
8. After the maintenance is complete, clean the tools and materials in time, and check whether metal objects remain inside or on the top of the product.
9. If you have any questions about the operation and maintenance of this product, please contact Deye ESS customer Service center, do not operate without authorization.

9.4 Disassembly and installation

If the battery pack or PDU is faulty, follow the steps below to disassembly and installation it.

9.4.1 Disassemble and install the battery pack

Step1

Turn off all power. Refer to **6.2 Power-off Procedure**. Take the manual service disconnect plug out.

Step 2

Remove all cables.

Step3

If you are disassembling the first through tenth battery pack, unscrew the battery pack to disassemble the pack.



After the repair is complete, re-screw the screw to complete the installation.

Step 4

If you are disassembling the eleventh and twelfth battery pack

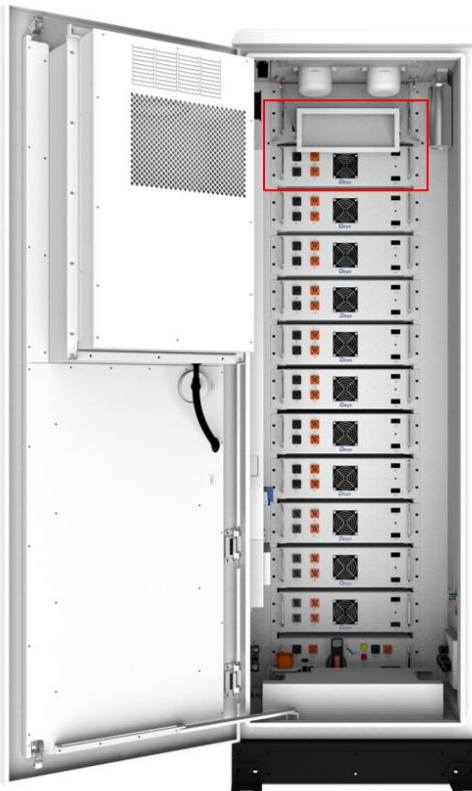

i. First disassemble the smoke detector and heat detector coverings. Then unscrew the air duct to disassemble it

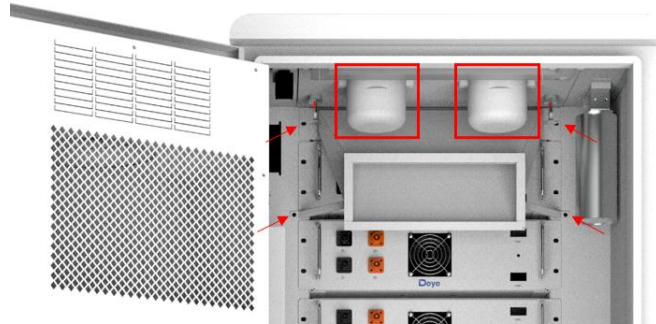

ii. Unscrew the battery pack and then disassemble the battery pack.

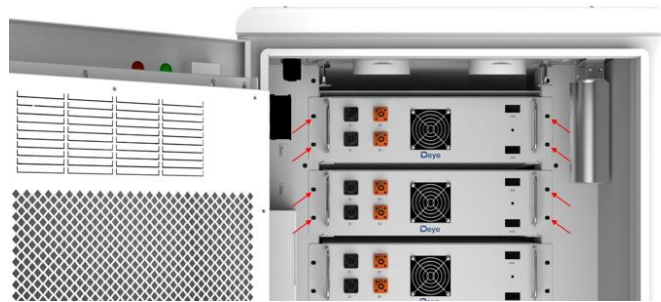

After repair, reinstall the battery pack and fix it with screws. Then install the smoke detector, heat detector and air duct to complete the installation.

9.4.2 Disassemble and install the PDU

Step1

Turn off all power. Refer to **6.2 Power-off Procedure**. Take the manual service disconnect plug out.

Step 2

Disassemble all cables.

Step 3

i. Disassemble the metal cover

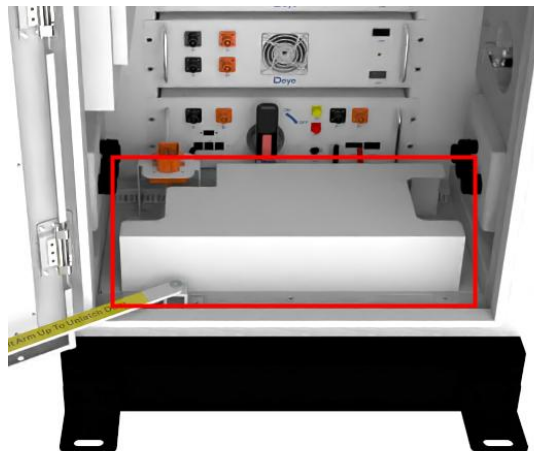

ii. Disassemble the transparent partition

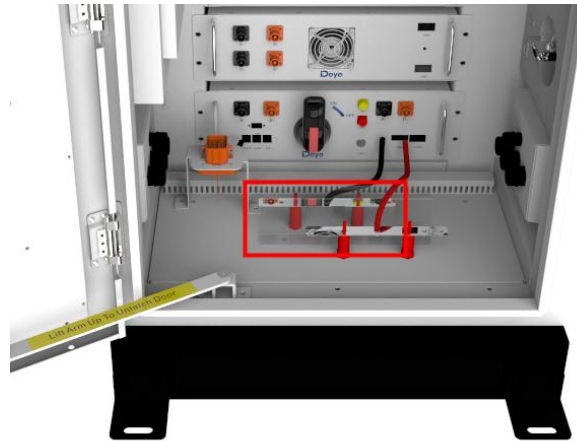

iii. Disassemble cables connecting the bronze

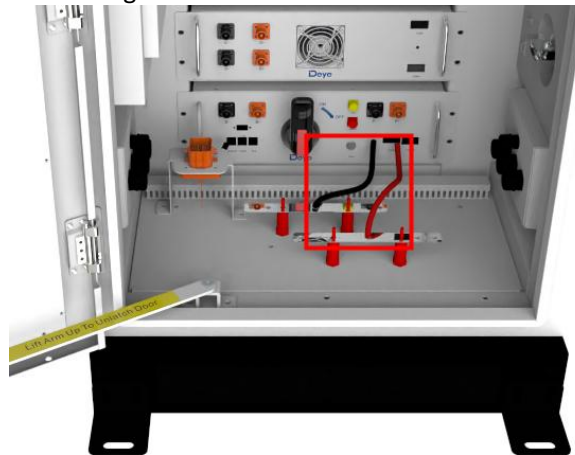

iv. Disassemble bronze and insulation columns

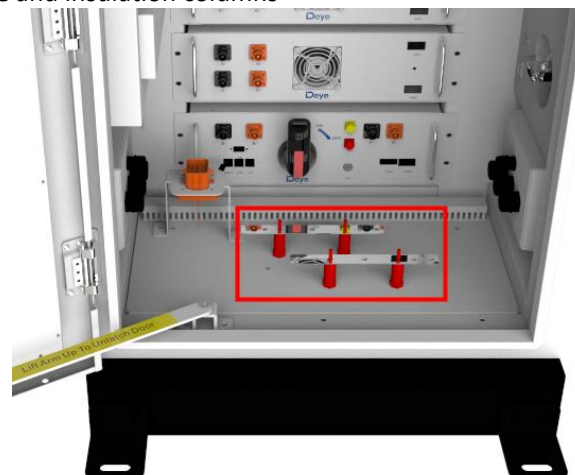

v. Disassemble the manual service disconnect.

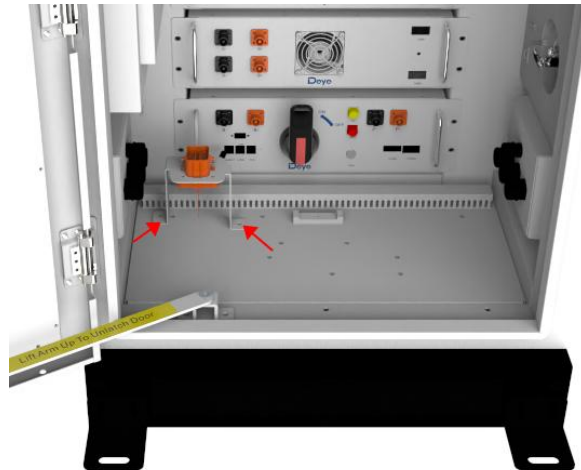

vi. Unscrew the PDU to disassemble the PDU.

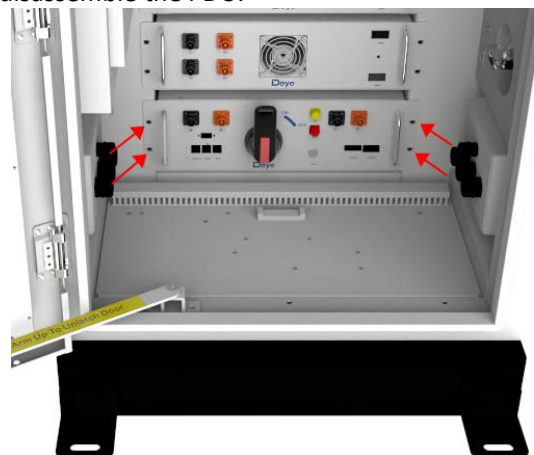

After the repair is complete, re-screw the screw to complete the installation.

10 Upgrade

10.1 USB Upgrade

- USB only supports USB flash drives with FAT32 file system format.
- In addition, there is a fixed folder name for storing upgrade files inside the U disk, the upgrade files must be placed in the first level of the directory folder: upgrade inside.
- At the same time, it is suggested that it is best to keep only the bin files that need to be upgraded.

10.2 PC Upgrade

1. Upgrade all the PACKs of the system

Step 1. After successfully connecting to the upper computer, select "Firmware - Browse - Upgrade

File"

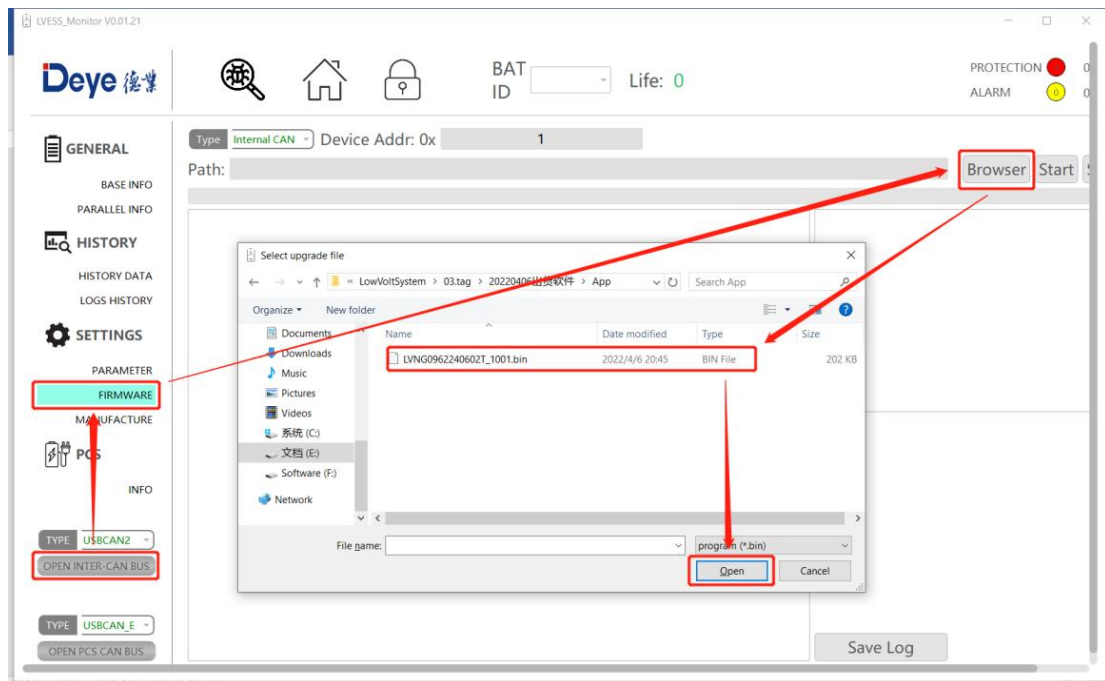

Step 2. Click to start

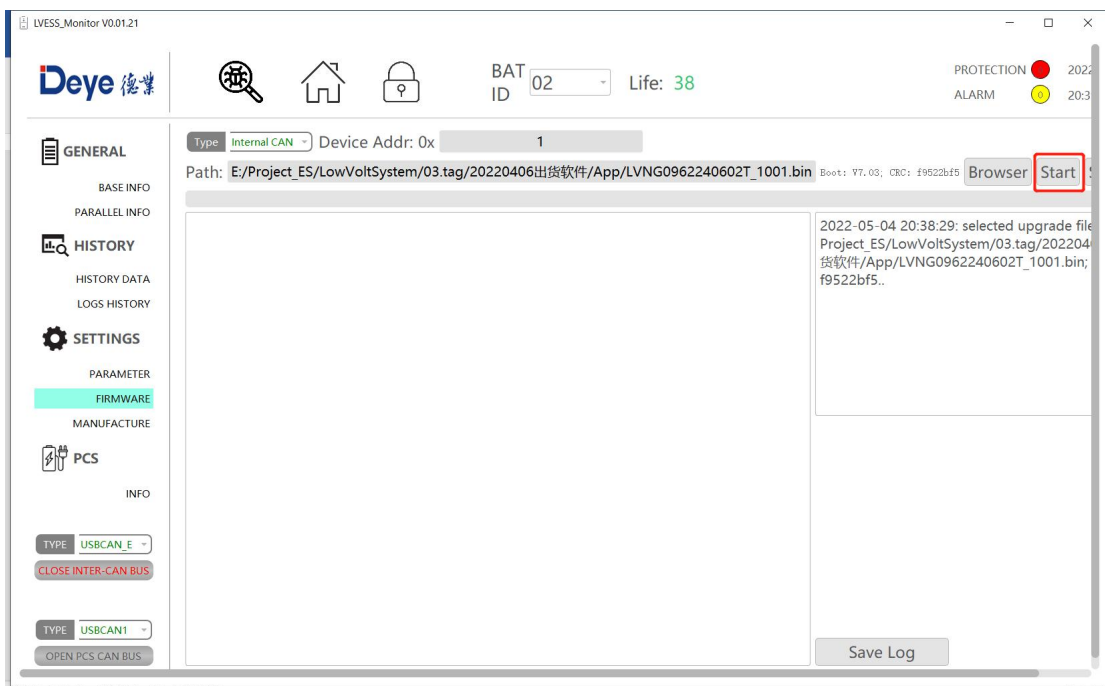

Step 3. If the system upgrade is successful, the lower right corner will prompt green success, and if it fails, it will prompt red failure.

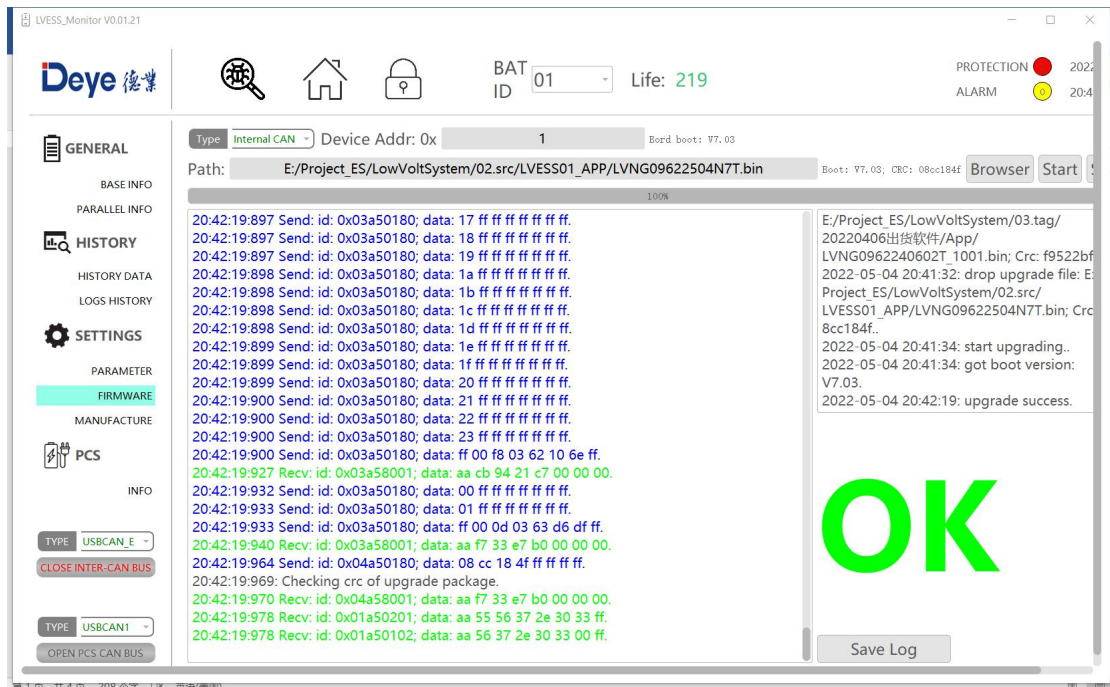

2. Upgrade a single PACK

Step 1. After successfully connecting to the host computer, select "Firmware - Browse - Upgrade File"

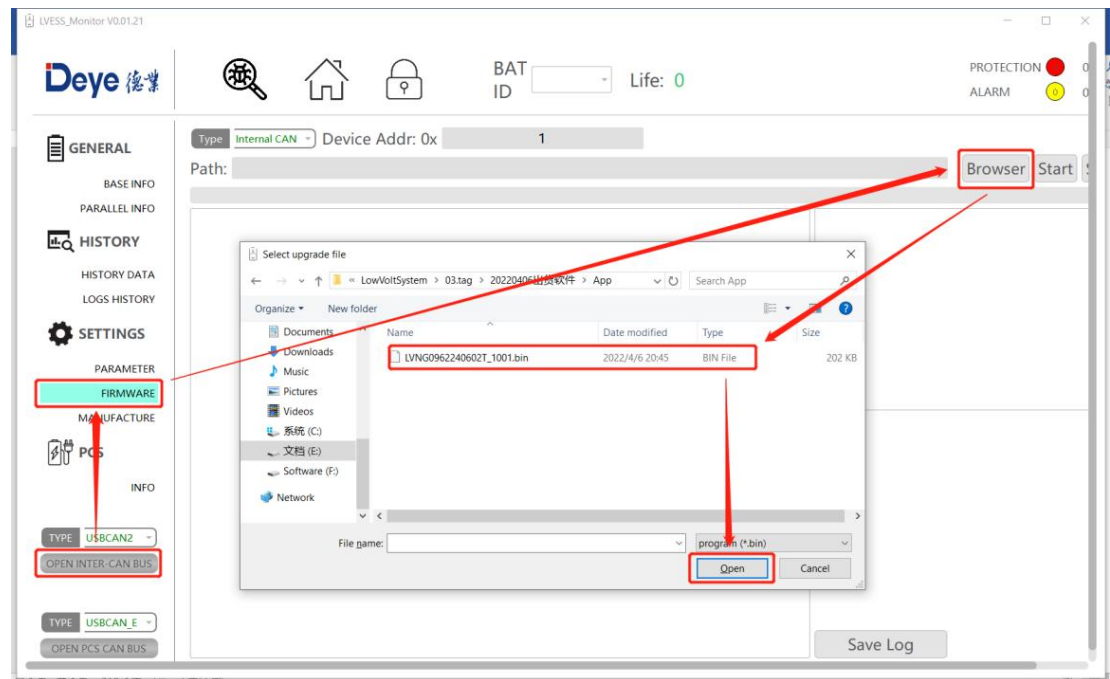

Step 2. Select the upgrade pack number, if there is "0x" in "Device Address", enter the corresponding hexadecimal number, such as upgrading Pack No. 29, enter 1D; if there is no "0x" in "Device Address", enter the corresponding decimal number No., if you upgrade Pack No. 25, enter 25.

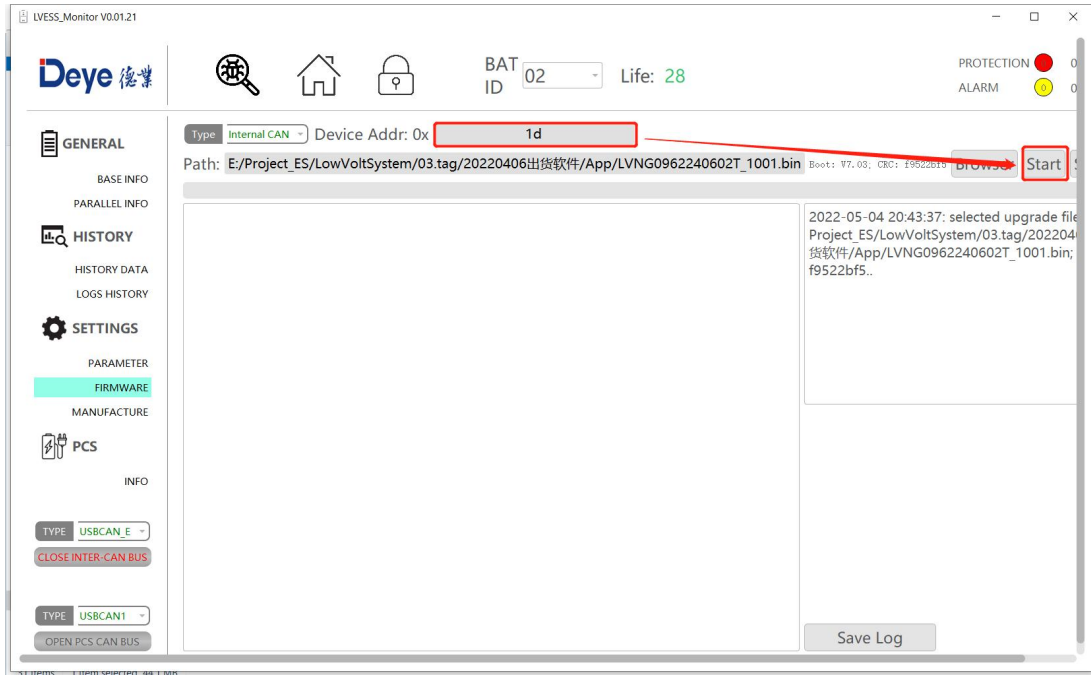

Step 3. If the system upgrade is successful, the lower right corner will prompt green success, and if it fails, it will prompt red NG.

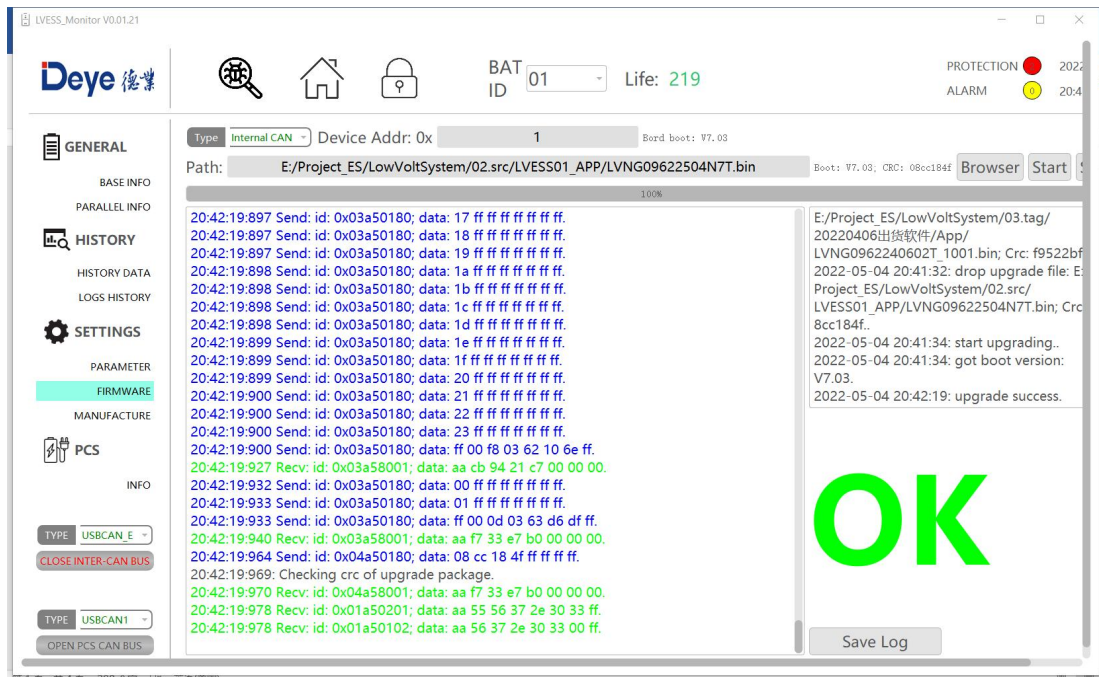

10.3 PCS Upgrade

Step1. Open the website <https://pv.inteless.com/plants>, enter the account number and password.

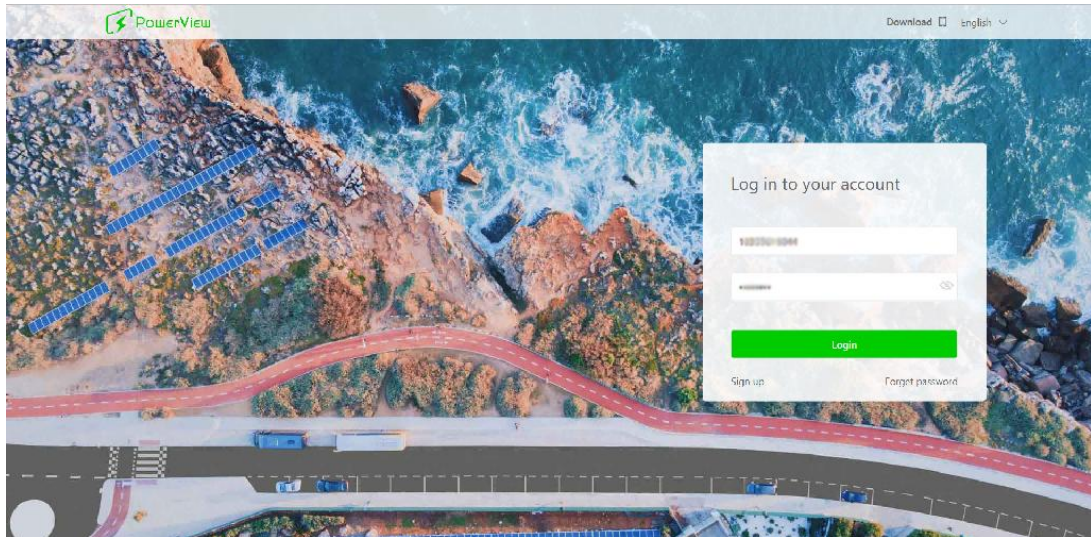

Step2. In the device list-inverter list, enter the collector serial number to find the target collector.

Status	SN	Device Alias	Power(W)	E-Today(kWh)	Version	Gateway	Plant Name	More
Normal	2112016566	2112016566	5781	0	6.0.0.6	E470121BE705	Stefan Smit	...
Normal	2112146182	2112146182	1802	0	3.3.6.7	E470121BF978	josef	...
Normal	2112086181	2112086181	0	0	3.3.6.7	E470121BF914	Robbie Frank	...
Normal	2201267151	2201267151	0	0	6.0.1.0	E47012214298	Marinda McDon...	...
Normal	2202214325	2202214325	355	0.2	3.3.7.1	E47012216017	Helene van Dyk	...

Step3. Select the target device and click Remote Upgrade.

Status	SN	Device Alias	Power(W)	E-Today(kWh)	Version	Gateway	Plant Name	More
Normal	2112016566	2112016566	5781	0	6.0.0.6	E470121BE705	Stefan Smit	...
Normal	2112146182	2112146182	1802	0	3.3.6.7	E470121BF978	josef	...
Normal	2112086181	2112086181	0	0	3.3.6.7	E470121BF914	Robbie Frank	...
Normal	2201267151	2201267151	0	0	6.0.1.0	E47012214298	Marinda McDon...	...
Normal	2202214325	2202214325	355	0.2	3.3.7.1	E47012216017	Helene van Dyk	...

Step4. Select "Energy Storage Machine/BMS" for the firmware type, select the firmware version provided by the technician, and click OK to start the upgrade.

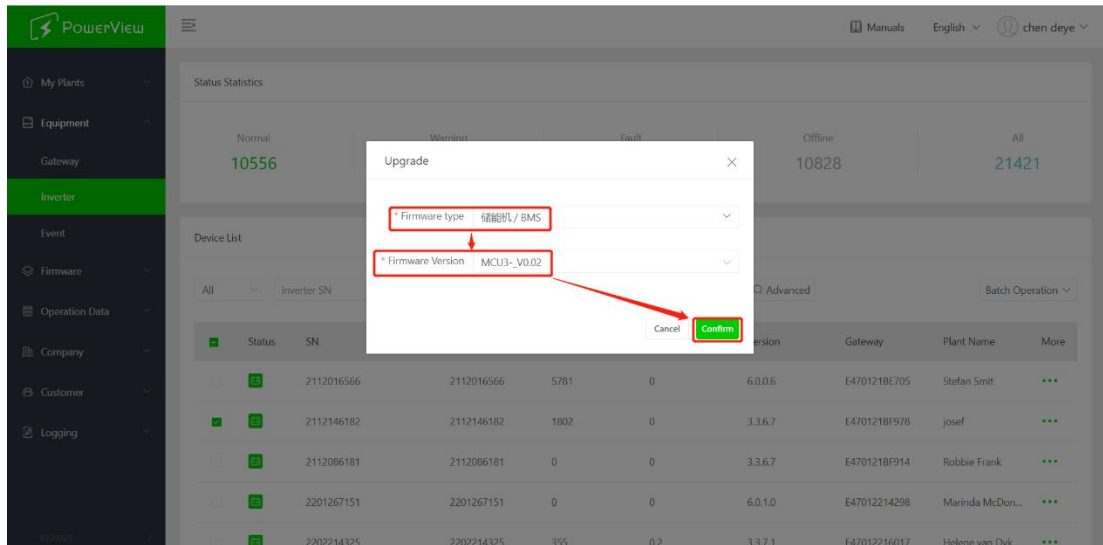

11. Battery recycling

When the equipment or internal equipment reaches the end of its service life, it cannot be disposed of together with domestic waste. Some internal components can be recycled, and some components will cause environmental pollution.

11.1 Recovery process and steps of cathode materials

Aluminum foil as collector is amphoteric metal. Firstly, it is dissolved in NaOH alkali solution to make aluminum enter the solution in the form of NaAlO_2 . After filtration, the filtrate is neutralized with sulfuric acid solution and precipitated to obtain $\text{Al}(\text{OH})_3$. When the pH value is above 9.0, most of the aluminum precipitates, and the obtained $\text{Al}(\text{OH})_3$ can reach the level of chemical purity after analysis.

The filter residue is dissolved with sulfuric acid and hydrogen peroxide, so that lithium iron phosphate enters the solution in the form of $\text{Fe}_2(\text{SO}_4)_3$ and Li_2SO_4 , and is separated from carbon black and carbon coated on the surface of lithium iron phosphate. After filtration and separation, the pH value of the filtrate is adjusted with NaOH and ammonia water. First, iron is precipitated with $\text{Fe}(\text{OH})_3$, and the remaining solution is precipitated with saturated Na_2CO_3 solution at 90°C .

Since FePO_4 is slightly dissolved in nitric acid, the filter residue is dissolved with nitric acid and hydrogen peroxide, which directly precipitates FePO_4 , separates impurities such as carbon black from acid solution, leaches $\text{Fe}(\text{OH})_3$ from filter residue respectively, and precipitates Li_2CO_3 with saturated Na_2CO_3 solution at 90°C .

11.2 Recovery of anode materials

The recovery process of anode materials is relatively simple. After the separation of anode plates, the purity of copper can be more than 99%, which can be used for further refining electrolytic copper.

11.3 List of recycling equipment

Recovery of diaphragm

The diaphragm material is mainly harmless, and has no recycling value.

List of recycling equipment

Automatic dismantling machine, pulverizes, wet gold pool, etc.

12 Contact Information

12.1 System Parameter

Model		GE-FL60
System Specification		
Nominal Output Power/UPS Power (W)		30000
AC Output Frequency and Voltage		50/60Hz; 3L/N/PE 120/208Vac
Grid Type		Three phase
Energy Configuration (kWh)		61.4
Module Capacity (Ah)		200
Dimension (W x D x H,mm)		735x1045x2235 (no contain inverter)
Weight Appr. (kg)		1015(battery)+80 (inverter)
AC Output Rated Current (A)		83.4
Battery Operating Voltage (V)		240~350
Charge/Discharge ² Current (A)	Recommend	50
	Nominal	100
	Peak Discharge (2 mins,25°C)	125
Max. charging/discharging efficiency		91%
Humidity		5%~85%RH
Battery Chemistry		LiFePO4
IP Rating of Enclosure		IP55
Installation Style		Floor-Mounted
Warranty		10 years
Battery Technical Specification		
Battery Module Nominal Voltage (V)		51.2
Battery Module Energy (kWh)		5.12
BMS Communication		CAN
Battery Module Dimension(W*D*H mm)		440×570×133
Battery Module Weight (kg)		45
Operating Temperature Range		Charge: 0~55°C/Discharge: -20°C~55°C
Storage Temperature (°C)		0~35
Cycle Life		≥6000(@25°C±2°C,0.5C/0.5C,70%EOL)
Battery Module Certification		FCC, UL1973,UL9540A , UN38.3

12.2 Contact Information

For more information on battery module handling, please contact us. Service hotline :+86 0574 8612 0560, Email :service-ess@deye.com.cn For more information, visit <http://deyeess.com>.

Comply with the regulations on waste battery disposal. Stop using the damaged battery immediately. Contact your installer or sales partner before processing. Keep the battery away from moisture or direct sunlight.